

56-45
53443
P. 85

CHAPTER 11

N92-15463

Observations and Theories Related to Antarctic Ozone Changes

Panel Members

D. Hartmann and R. T. Watson, Co-Chairs

R. A. Cox UN 078125

C. Kolb

J. Mahlman

M. McElroy

A. Plumb

V. Ramanathan

M. Schoeberl - NC 999967

S. Solomon - NJ 920944

R. Stolarski - NC 999967

N. D. Sze

A. Tuck - NJ 920944

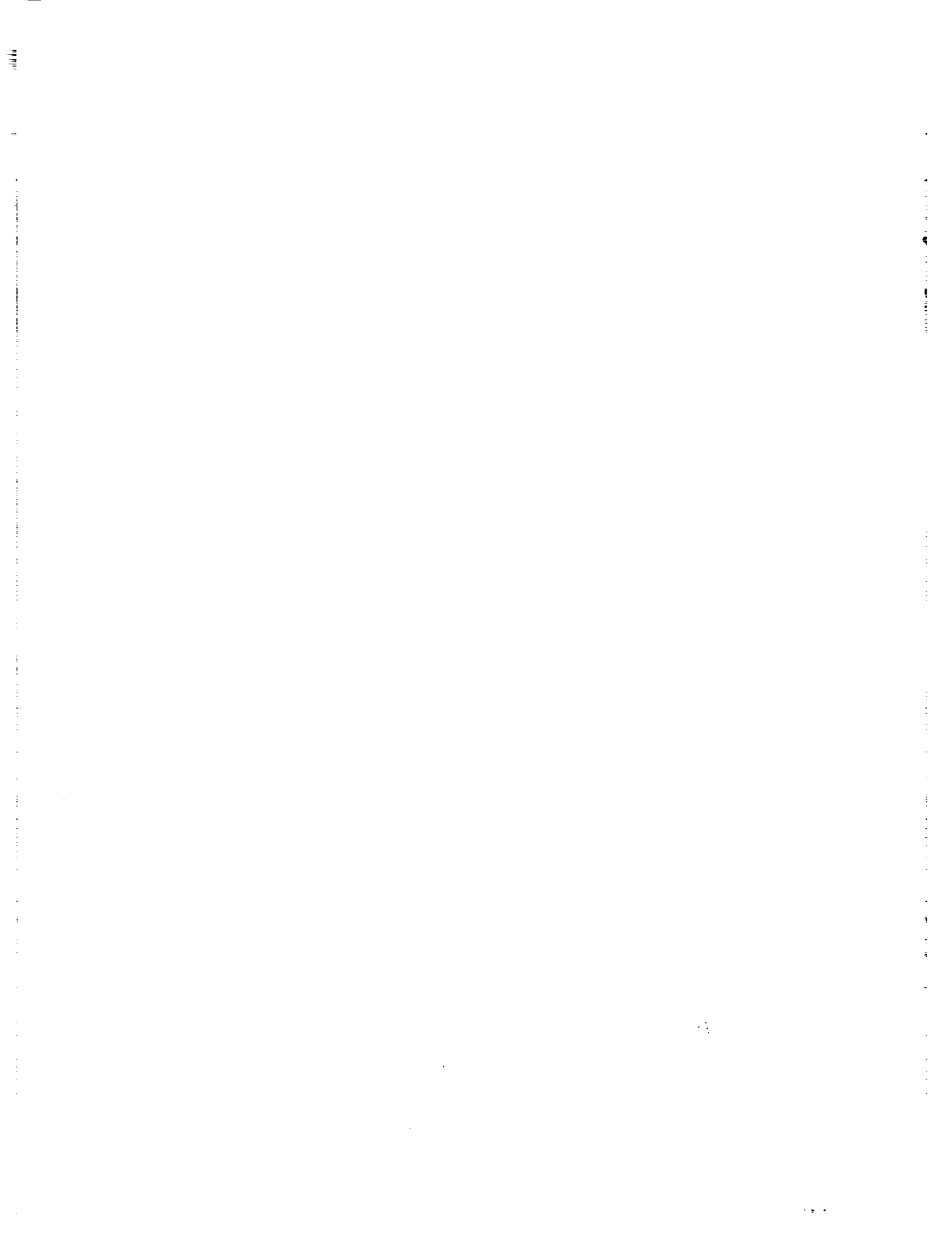

Chapter 11

Observations and Theories Related to Antarctic Ozone Changes

Contents

11.1	INTRODUCTION	669
11.2	OBSERVATIONS	669
11.2.1	Ozone Climatology and Trends	669
11.2.1.1	Total Ozone Changes	670
11.2.1.2	Altitude Dependence of Changes in Ozone	685
11.2.1.3	Summary of Ozone Observations	691
11.2.2	Morphology of Polar Stratospheric Clouds	692
11.2.3	Antarctic Temperature Trends	695
11.2.3.1	Introduction	695
11.2.3.2	Data Intercomparisons	695
11.2.3.3	Rawinsonde Analyses	699
11.2.3.4	Analyzed Fields	704
11.2.3.5	Conclusion	704
11.3	TRANSPORT THEORIES FOR THE ANTARCTIC OZONE HOLE	704
11.3.1	Basic Dynamical Concepts and Ozone Transport	704
11.3.2	Transport Theories for the Ozone Hole	710
11.3.3	Evidence For and Against Transport Theories for the Ozone Hole	713
11.3.3.1	Evidence for a Climate Drift in the Southern Stratosphere	713
11.3.3.2	Evidence for Upward Motion at High Latitudes in Spring	721
11.3.4	Summary	724
11.4	CHEMICAL THEORIES AND OBSERVATIONS	725
11.4.1	Chemical Theories	725
11.4.1.1	Homogeneous Reactions	725
11.4.1.2	Character and Role of Polar Stratospheric Clouds	729
11.4.1.3	Heterogeneous Reactions	730
11.4.1.4	Summary	734
11.4.2	Observations Relevant to Testing the Chemical Theories	734
11.4.2.1	Observational Data Base	734
11.4.2.2	Comparison of Theory and Observations	735
11.4.2.3	Observations of Halogen Species	735
11.4.2.4	Observations of Nitrogen Species	740
11.5	CAN WE EXPLAIN THE OBSERVED SPRINGTIME OZONE TREND OVER ANTARCTICA IN THE LAST 20 YEARS?	743

11.6	WHAT ARE THE IMPLICATIONS FOR THE GLOBAL EARTH'S SYSTEM OF THE OZONE CHANGES OBSERVED OVER ANTARCTICA?	744
11.7	QUESTIONS FOR THE FUTURE	745
11.8	SUMMARY	746
11.8.1	Ozone Observations	746
11.8.2	Polar Stratospheric Cloud Observations	747
11.8.3	Temperature Observations	747
11.8.4	Transport Theories for the Antarctic Ozone Hole	748
11.8.5	Chemical Theories and Observations for the Antarctic Ozone Hole	748

11.1 INTRODUCTION

In 1985, there was a report (Farman et al., 1985) of a large, sudden, and unanticipated decrease in the abundance of springtime Antarctic ozone over the last decade. By 1987, ozone decreases of more than 50 percent in the total column, and 95 percent locally between 15 and 20 km, had been observed. A change of this magnitude was not predicted by any of the photochemical models. The scientific community quickly rose to the challenge of explaining this remarkable discovery; theoreticians soon developed a series of chemical and dynamical hypotheses to explain the ozone loss. Unfortunately, there were inadequate observational data to differentiate among the different theories. Consequently, field measurement campaigns were quickly organized to determine the chemical composition and physical structure of the springtime stratosphere over Antarctica and test the theories. Three basic theories were proposed to explain the springtime ozone hole:

- The ozone hole is caused by the increasing atmospheric loading of manmade chemicals containing chlorine (chlorofluorocarbons [CFC's]) and bromine (halons). These chemicals efficiently destroy ozone in the lower stratosphere in the Antarctic because of the special geophysical conditions—of an isolated air mass (polar vortex) with very cold temperatures—that exist there.
- The circulation of the atmosphere in spring has changed from being predominantly downward over Antarctica to upward. This would mean that ozone-poor air from the troposphere—instead of ozone-rich air from the upper stratosphere—would be transported into the lower Antarctic stratosphere.
- The abundance of the oxides of nitrogen in the lower Antarctic stratosphere is periodically enhanced by solar activity. Nitrogen oxides are produced in the upper mesosphere and thermosphere and then transported downward into the lower stratosphere in Antarctica, resulting in the chemical destruction of ozone.

This chapter discusses the climatology and trends of ozone, temperature, and polar stratospheric clouds; the transport and chemical theories for the Antarctic ozone hole; and the observational evidence to test the different theories.

11.2 OBSERVATIONS

11.2.1 Ozone Climatology and Trends

Until recently, attention has focused primarily on the Antarctic springtime variations in total ozone; however, many questions have arisen concerning the overall seasonal and year-to-year variations throughout the Southern Hemisphere. October is the month originally emphasized by Farman et al. (1985) because it is the month of most dramatic effect. This section will discuss the spatial and temporal extent of the changes in both the total column content and the vertical distribution of ozone over and around Antarctica. Ozone changes from year to year, and within a single year, are addressed. The Total Ozone Mapping Spectrometer (TOMS) data shown in this chapter have not been corrected for the drift against the Dobson network, which has been discussed in great detail in earlier chapters. The drift of TOMS data with respect to the Dobson network was reported to be approximately 0.4 percent per year, which corresponds to a total drift of about 3.6 percent from launch in late 1978 to the present.

ANTARCTIC OZONE CHANGES

Consequently, TOMS ozone changes in excess of this can be considered real and not an artifact of the data analysis procedures. Most of the ozone changes discussed in this chapter are significantly greater than the uncertainty in the TOMS calibration, but in identifying the spatial and seasonal extent of the ozone hole phenomenon, it is important to appreciate the accuracy and precision of the TOMS data. Whenever ozone changes are quantitatively discussed in this chapter, an allowance of 10 to 15 Dobson Units (DU) has been made for the TOMS–Dobson network bias, even though the data in the figures have not been corrected.

11.2.1.1 Total Ozone Changes

A significant change in the springtime total ozone content over the Antarctic was first reported by the British Antarctic Survey using the Dobson station data at Halley Bay (76°S, 27°W), with a smaller change seen at the Argentine Islands (65°S, 64°W) (Farman et al., 1985). Figure 11.1 shows the October mean measurements of total ozone from Halley Bay from 1956 through 1987 and the October means of satellite data from satellite overpasses of the Halley Bay station. The 1970 through 1972 satellite data are from the BUV experiment aboard the Nimbus-4 satellite (see, e.g., Hilsenrath and Schlesinger, 1981, and references therein). From 1979 through 1986, October mean data over Halley Bay from the SBUV instrument aboard Nimbus-7 are shown (Stolarski et al., 1986). It is clear from both the ground-based and satellite data shown in Figure 11.1 that the abundance of ozone dropped rapidly after the late 1970's.

Whether the abundance of ozone was already decreasing during the late 1960's and throughout the 1970's, or the decrease started abruptly at the end of the 1970's, is a critical question.

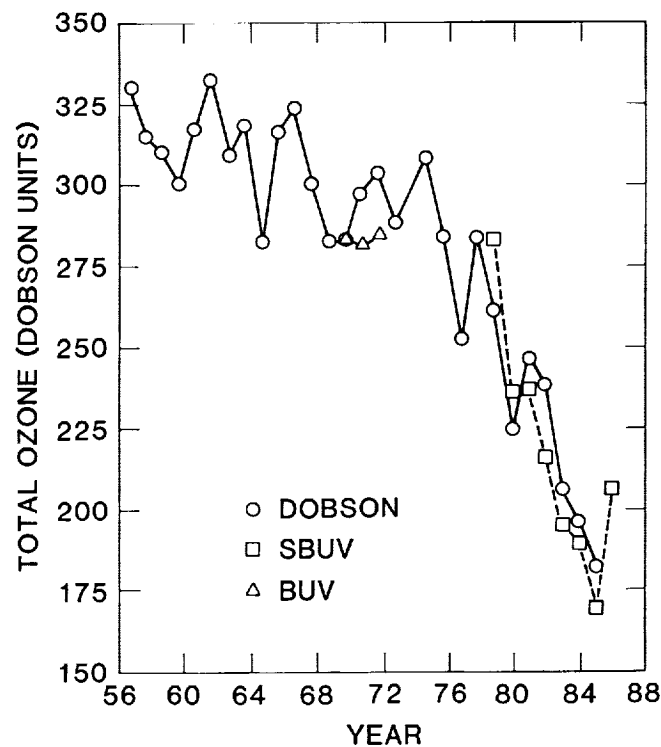

Figure 11.1. October monthly mean total ozone measurements over Halley Bay. Circles are Dobson measurements (Farman et al., 1986). Triangles are Nimbus-4 BUV measurements from 1970 to 1972 and boxes are Nimbus-7 TOMS measurements from 1979 to 1986 (Stolarski et al., 1988).

ANTARCTIC OZONE CHANGES

Inspection of the Halley Bay data tends to suggest that the abundance of ozone was somewhat lower during the 1970's, compared to the late 1950's and 1960's. However, the Halley Bay satellite overpass data indicate little change in total ozone between 1970–1972 and 1979; Table 11.1 shows that there was no significant change in zonal mean ozone from 70°S–80°S from the early 1970's—i.e., 1970–1972, to 1979. Figure 11.2 shows the seasonal deviations in total column ozone from the Argentine Islands, Syowa (69°S, 40°E), Halley Bay, and the South Pole (90°S)

Table 11.1 Zonal mean, minimum, and maximum ozone values for the month of October each year for the 70°S–80°S latitude zone from Nimbus-4 BUUV (1970–1972) and from Nimbus-7 SBUV (1979–1984).

Year	Minimum	Mean	Maximum
1970	240	306	484
1971	249	334	482
1972	237	337	539
1979	235	333	515
1980	212	270	467
1981	206	266	422
1982	186	283	494
1983	166	245	479
1984	162	240	446

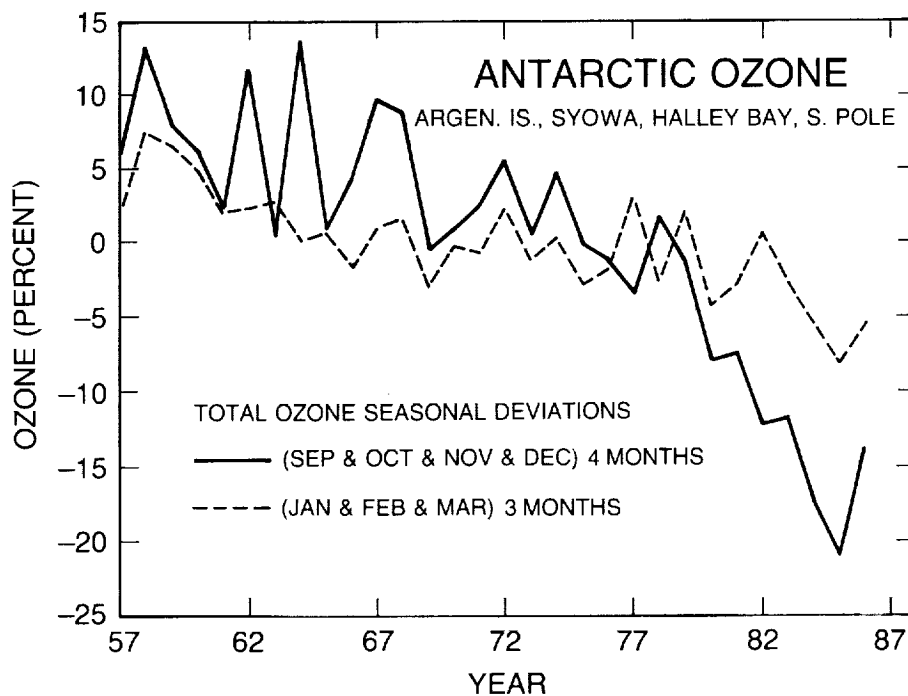

Figure 11.2. Deviation of total ozone from seasonal mean over Argentine Islands, Syowa, Halley Bay, and South Pole stations from 1957 through 1986. Solid line is for spring (Sept.–Dec.); dashed line is summer–early fall (Jan.–Mar.) (*Proc. Quadr. Ozone Symp.*, in press).

ANTARCTIC OZONE CHANGES

from 1957 to 1986 for the periods September to December (spring) and January to March (summer). The data appear to indicate a springtime decrease starting in the mid-1970's, with little if any decrease in summertime ozone. Given the high level of interannual variability in Antarctic ozone, it is difficult to draw strong quantitative conclusions about the magnitude of ozone decreases during the 1970's.

Figure 11.3 shows October monthly mean maps for total column ozone for each year from 1979 to 1986; Figures 11.4a and 11.4b show October monthly mean maps for total column ozone for odd and even years, respectively, from 1979 to 1987; Figures 11.5a and 11.5b show September monthly mean maps for total column ozone for odd and even years, respectively, from 1979 to 1987, from the TOMS instrument. The maps are polar orthographic projections with the South Pole at the center and the Equator at the outside edge. The satellite data not only confirm the decrease reported from groundstation data, but demonstrate that the phenomenon is of large regional scale, at least the size of the Antarctic continent. These maps clearly show that the abundance of ozone in 1987 is the lowest since satellite measurements began, and that there has been a decrease of approximately 150 DU in the October mean values of total ozone, and of approximately 100 DU in September's within the region of the ozone minimum that is approximately coincident with the Antarctic continent. They also show that the maximum values of the

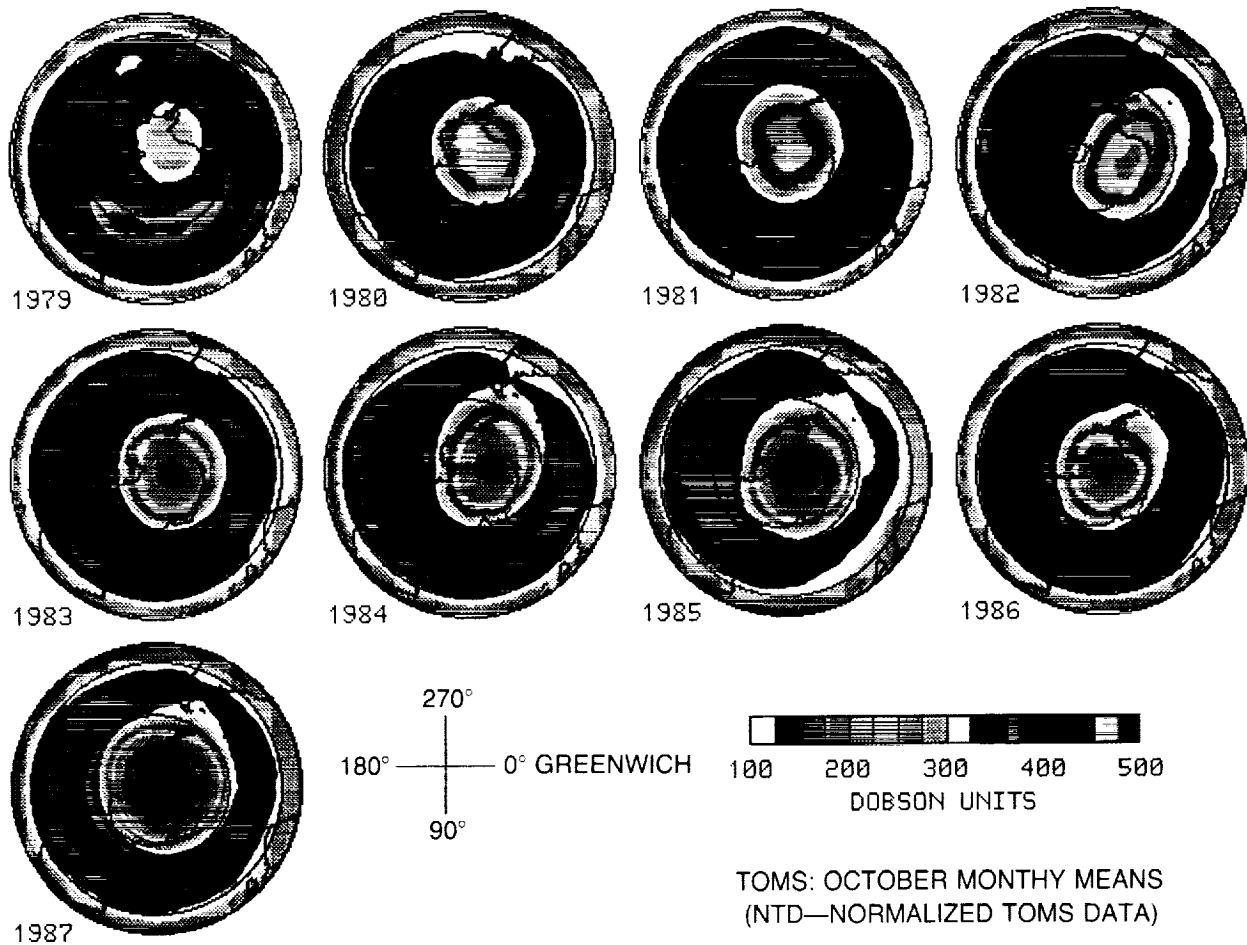

Figure 11.3. TOMS maps of Southern Hemisphere, total ozone for Octobers from 1979 through 1987. Maps are polar orthographic projections with Equator at outside and South Pole at center.

ANTARCTIC OZONE CHANGES

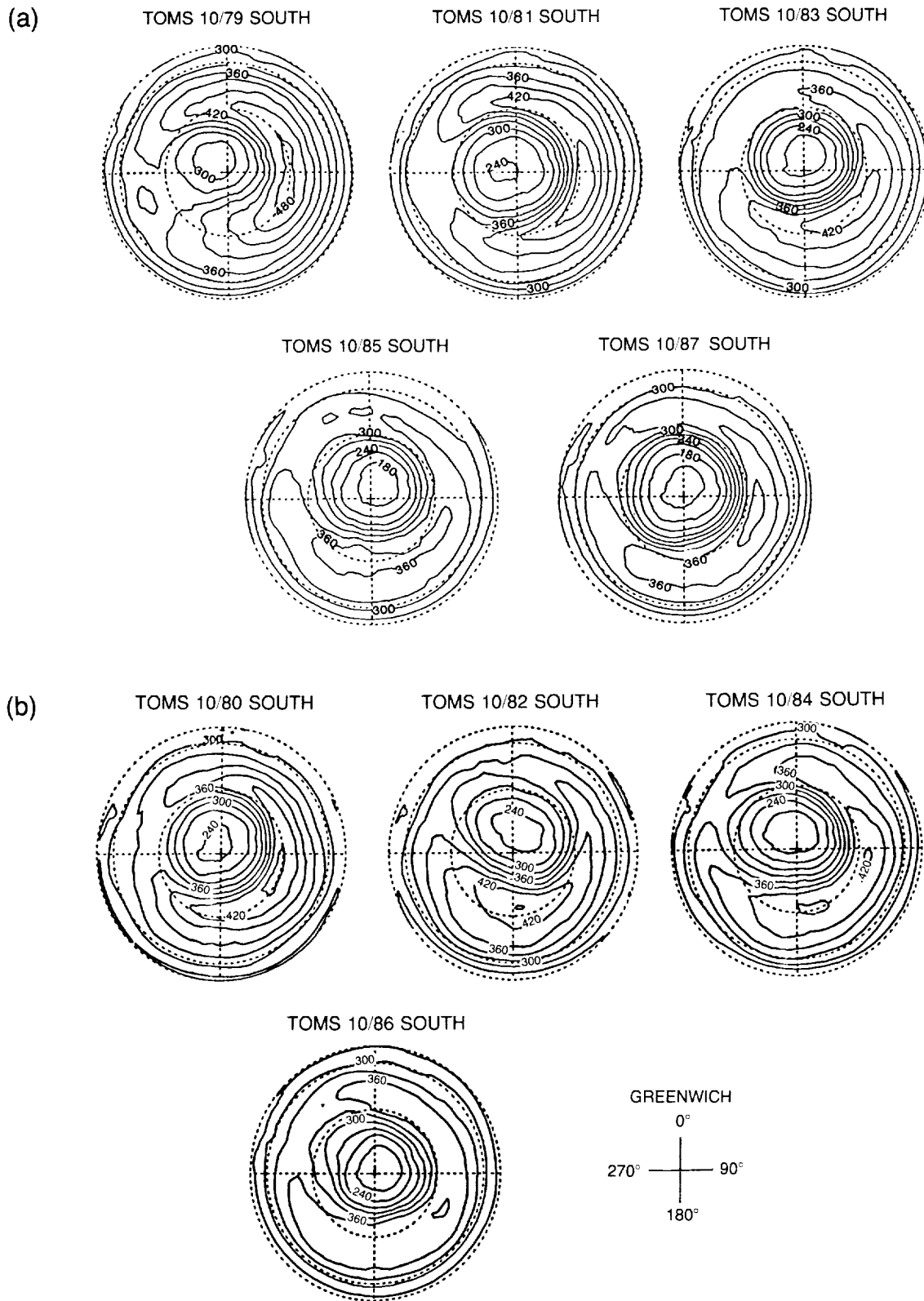

Figure 11.4. Polar orthographic maps of TOMS October mean Southern Hemisphere total ozone for (a) odd years and (b) even years.

ANTARCTIC OZONE CHANGES

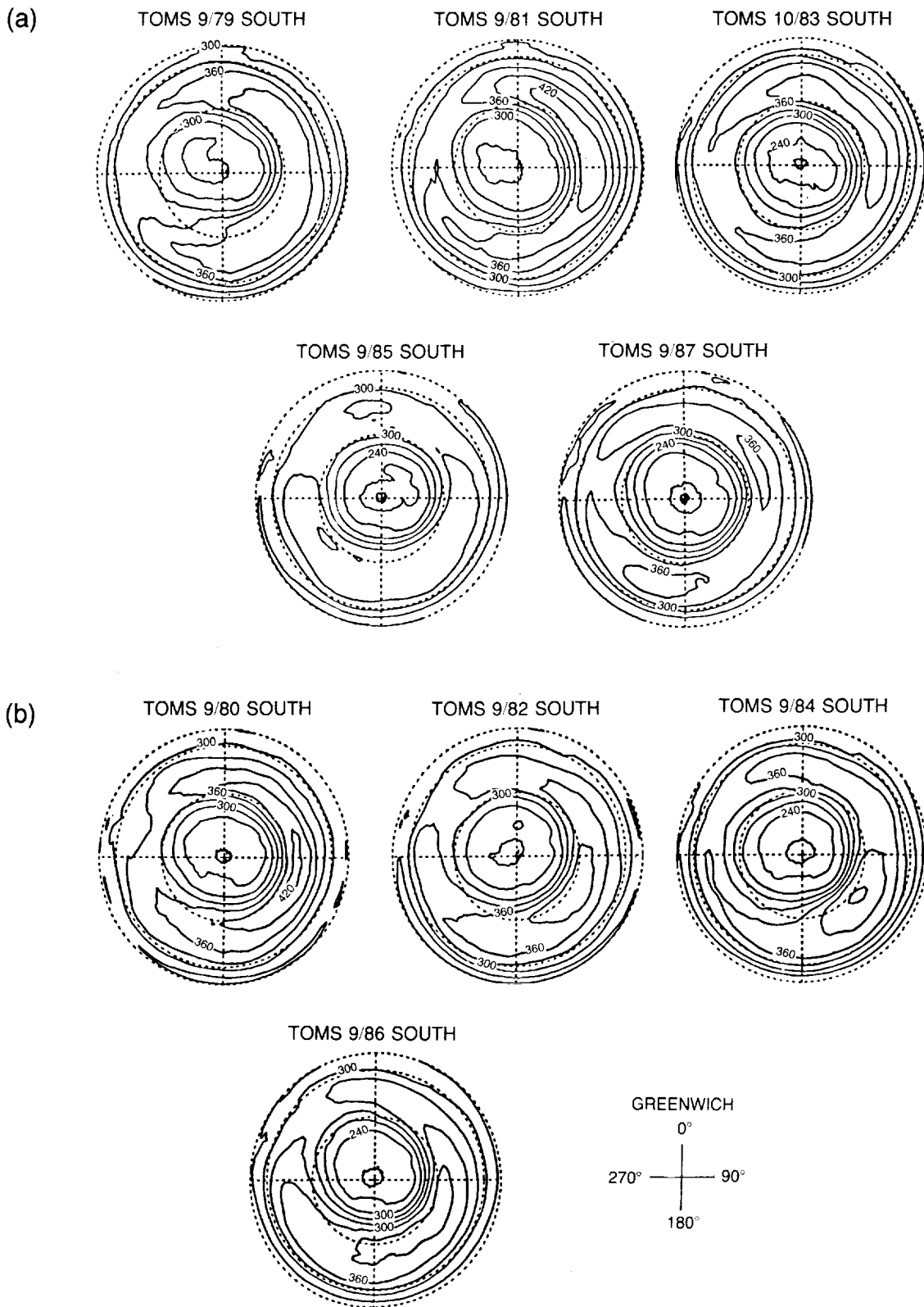

Figure 11.5. Polar orthographic maps of TOMS September mean Southern Hemisphere total ozone for (a) odd years and (b) even years.

September and October mean total ozone in the circumpolar ring at about 55°S–60°S have decreased by about 75–100 DU. Thus, the decrease in the maximum is nearly as large as the decrease in the minimum region in absolute DU, but is less than half that in the minimum region in percent (this is shown in greater detail in later figures). Note also, in Figures 11.3, 11.4, and 11.5, that the position of the maximum in the circumpolar ring varies by about 90 degrees in longitude, tending to rotate from about 90°E in 1979 to about 180°E in 1985 and 1986, possibly returning to about 135°E in 1987. This, coupled with the lack of stations in this region, makes it difficult to confirm the reported changes from ground-based Dobson measurements. The only station available for comparison is at MacQuarie Island, Australia, which shows little or no trend (Bojkov, 1986a). This seems to be consistent with the satellite data that indicate that MacQuarie Island is on the edge of the maximum region, which has rotated toward the station while decreasing in magnitude.

Figures 11.6, 11.7, and 11.8 (Krueger et al., 1988) show the daily zonal mean values for total ozone from July 29 through October 7 for 60°S, 70°S, and 80°S, respectively, for the years from 1984 to 1987, with 1979 as a reference year. Table 11.2 shows the monthly zonal mean values for total ozone from August through November from 1978 to 1987 for latitude belts 39°–41°S, 49°–51°S, 59°–61°S, 69°–71°S, and 79°–81°S. The ozone levels in 1987 were between 100 and 150 DU lower than in 1979 at all latitudes south of 70 degrees, and between 75 and 100 DU lower at 60°S. These changes are far in excess of the uncertainty in the TOMS calibration, which, as stated earlier, amounts to about 10–15 DU.

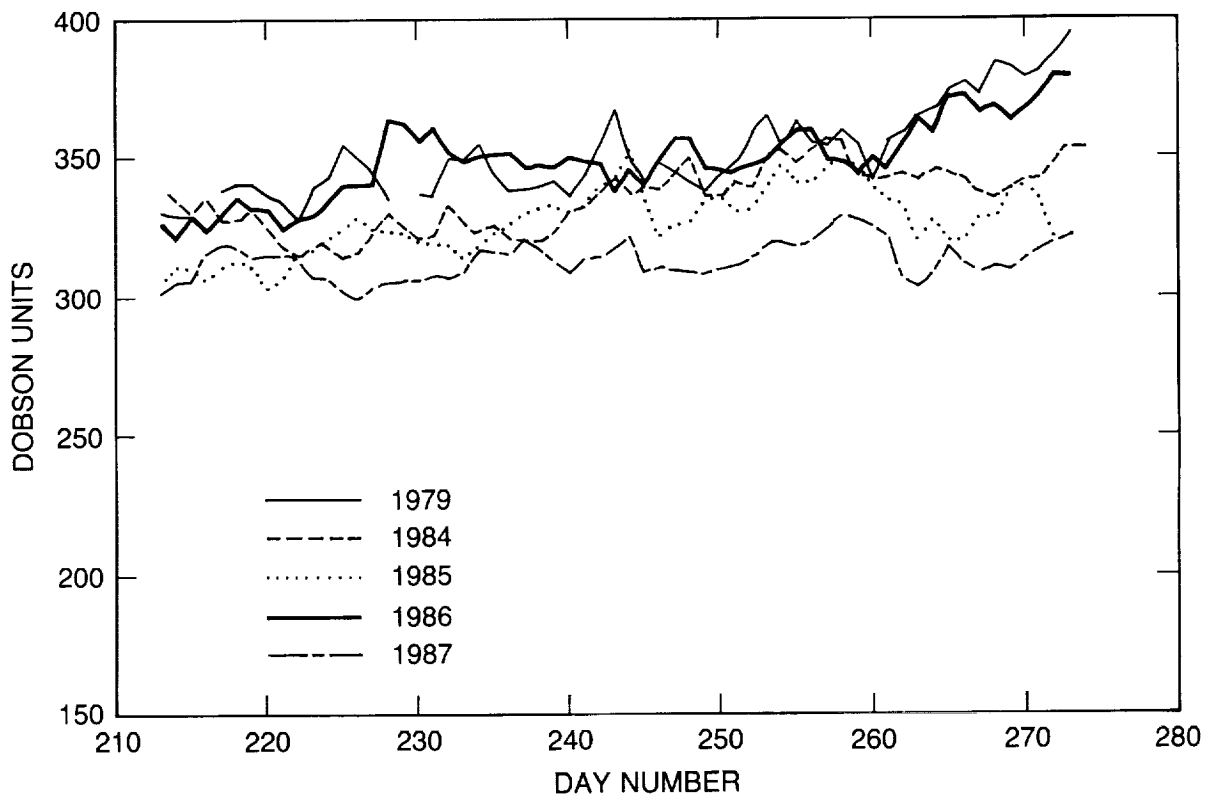

Figure 11.6. Daily zonal mean TOMS total column ozone for latitude band 60°S \pm 1° from day 210 to day 280, yearly from 1984 to 1987, with 1979 as reference year, using normalized TOMS data (NTD).

ANTARCTIC OZONE CHANGES

Table 11.2 TOMS Total Ozone Monthly Zonal Average

Degrees South Latitude	1978	1979	1980	1981	1982	1983	1984	1985	1986	1987
August										
39-41	—	362	335	354	337	347	354	317	343	323
49-51	—	361	362	362	352	343	359	328	358	326
59-61	—	344	353	339	329	331	323	315	333	301
69-71	—	301	301	304	283	290	265	263	271	249
79-81	—	—	—	—	—	—	—	—	—	—
September										
39-41	—	368	343	363	345	359	364	328	348	338
49-51	—	381	375	395	360	377	370	338	365	348
59-61	—	365	368	371	348	354	341	328	347	306
69-71	—	307	287	296	276	269	261	249	265	216
79-81	—	280	261	274	250	238	227	217	228	196
October										
39-41	—	367	342	362	349	350	349	329	348	339
49-51	—	401	376	397	373	376	375	343	370	358
59-61	—	421	403	401	366	380	365	329	358	326
69-71	—	378	321	307	324	300	290	258	288	215
79-81	—	319	255	255	270	224	225	192	212	157
November										
39-41	336	349	325	337	330	328	326	306	316	324
49-51	371	380	362	362	359	349	356	330	345	342
59-61	397	403	388	390	373	371	376	342	356	333
69-71	397	385	359	369	345	359	347	307	345	248
79-81	379	357	326	323	289	329	296	260	328	195

Careful examination of Figures 11.6–11.8 suggests that the abundance of ozone at the end of the polar night decreased from 1979 to 1987. From Figure 11.7, it appears that the zonal mean abundance of ozone at 70°S at the beginning of August decreased by about 40 to 50 DU. A key question is whether this indicates removal of ozone during the polar night, or whether ozone decreased throughout the year. Figures 11.9, 11.10, and 11.11 show zonal mean total ozone at 60°S, 70°S, and 80°S from 1979 to 1987 for all months of the year. These figures indicate that while the decrease in ozone is largest in the Antarctic spring, ozone decreased by about 40 to 50 DU at each of these latitudes throughout the year. Figures 11.12 and 11.13 (Krueger, private communication) show the October and January monthly mean values of total ozone, respectively, for 1987, the average of 1979 to 1982, and the differences between them. It is clear that at all latitudes, but especially south of about 50°S, total ozone is lower in 1987 than it was between 1979 and 1982 during both October and January.

ANTARCTIC OZONE CHANGES

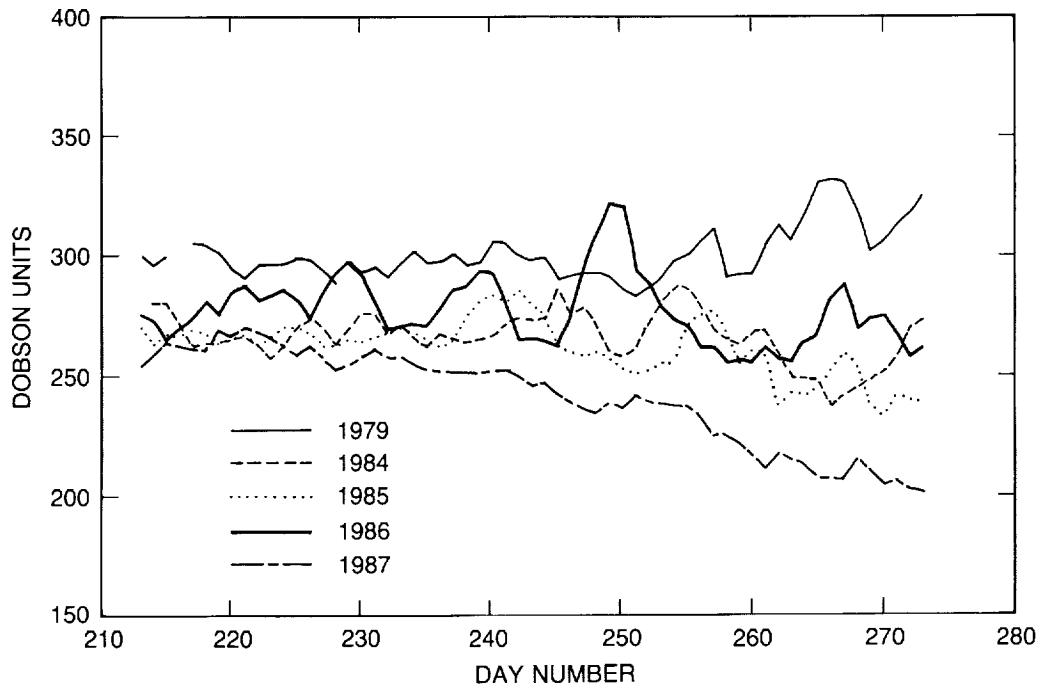

Figure 11.7. Daily zonal mean TOMS total column ozone for latitude band 70°S ± 1° from day 210 to day 280, yearly from 1984 to 1987, with 1979 as reference year, using normalized TOMS data (NTD).

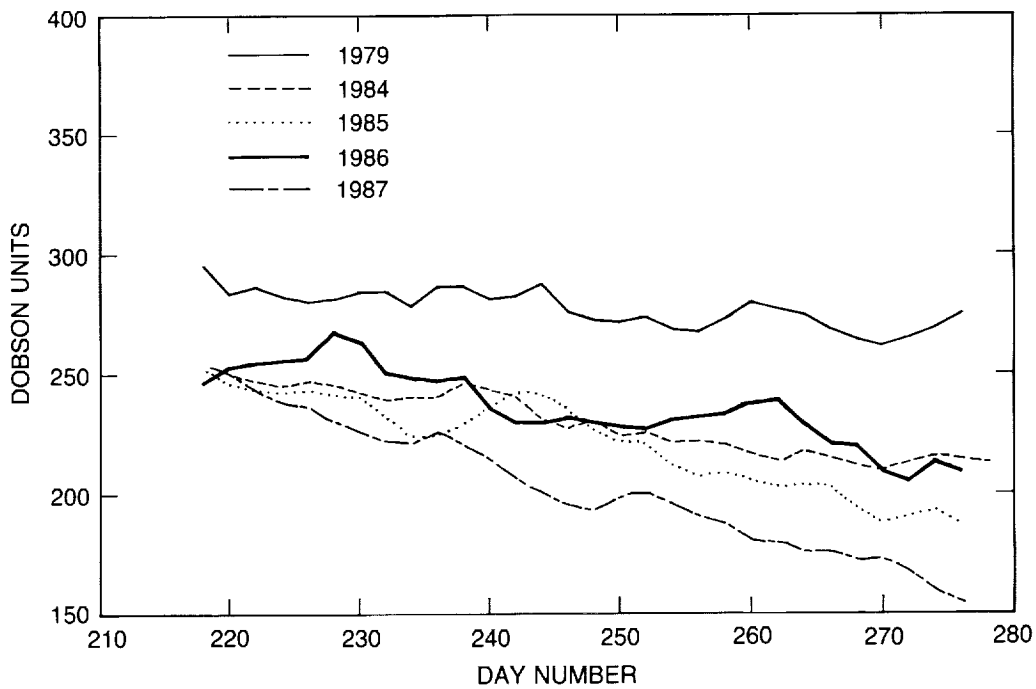

Figure 11.8. Daily zonal mean TOMS total column ozone for latitude band 80°S ± 1° from day 210 to day 280, yearly from 1984 to 1987, with 1979 as reference year, using normalized TOMS data (NTD).

ANTARCTIC OZONE CHANGES

Figures 11.12 and 11.13 show September and October mean total ozone as a function of latitude from 1979 to 1987 and clearly demonstrate that ozone decreased in 1987 to a value clearly less than other years at all latitudes south of about 50°S during these months. Figures 11.14 and 11.16 show that the area weighted mean of the total ozone from 44°S to the South Pole has decreased by about 40 to 50 DU over the last 9 years. A similar result is obtained upon examination of total ozone data from 30°S to 70°S. As has already been noted, the TOMS data indicate that within a given year, total ozone is rising during September in the circumpolar maximum region near 60°S in such a way that the area weighted mean of the total ozone remains approximately constant within a given year over the area from 45°S to the South Pole (Schoeberl and Stolarski, 1988), as shown in Figures 11.14 and 11.15. The significance of this observation has been disputed because of the poorly known variations of the transport of ozone from the region below 45°S latitude. In addition, it should be noted that the area weighted mean value of ozone did not remain constant during 1987. Figure 11.16 shows that ozone has decreased between 1986–1987 and 1979–1980 throughout the year and from the South Pole to about 50–60°S.

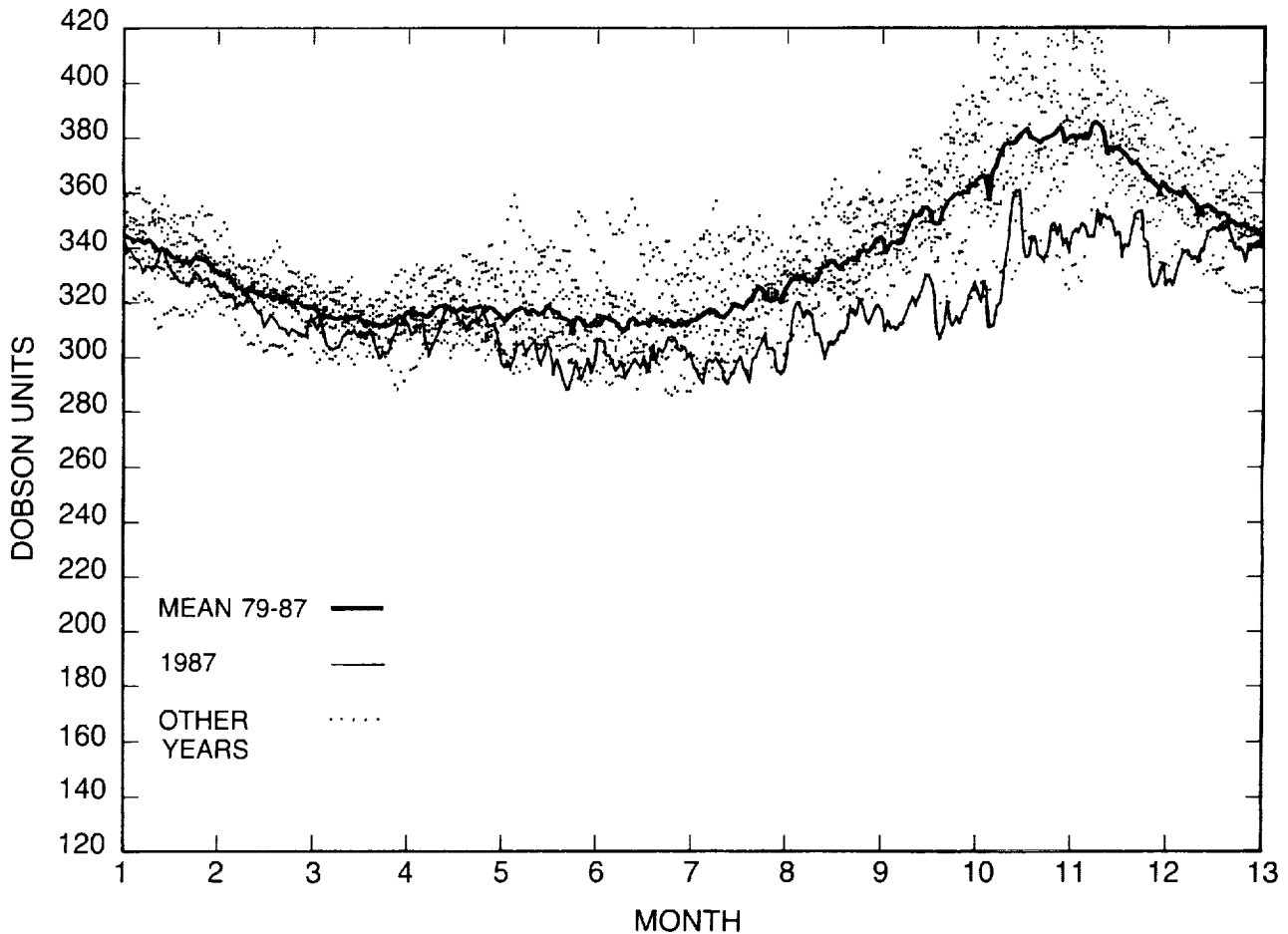

Figure 11.9. Daily zonal mean TOMS total column ozone versus time of year at 60°S for the years 1979 through 1987. Heavy line shows the mean for all years, thin solid line shows 1987, and dots are daily values for all years 1979–1986 (normalized TOMS data used).

ANTARCTIC OZONE CHANGES

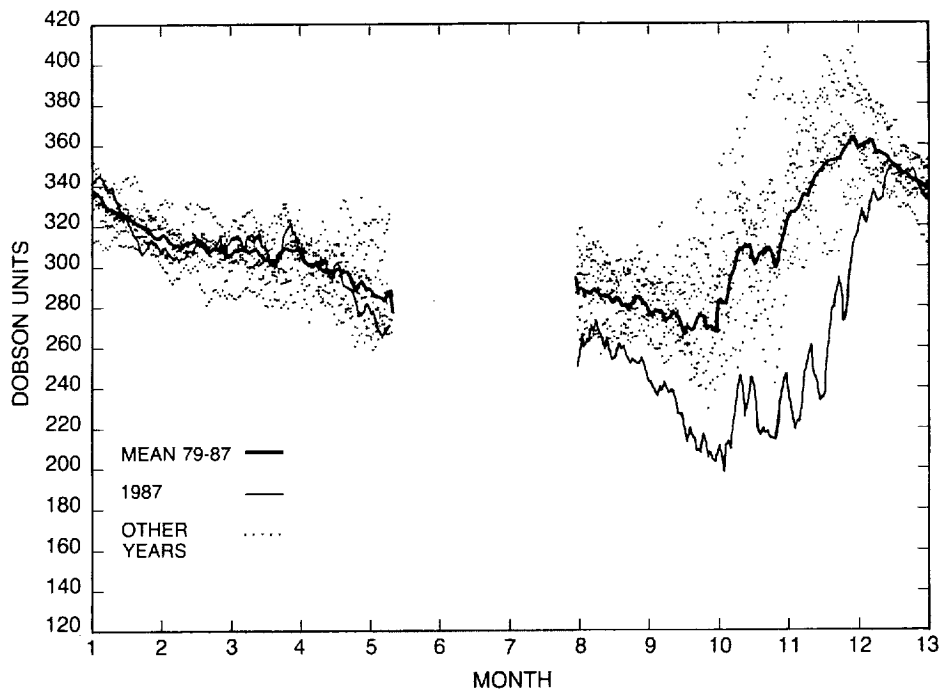

Figure 11.10. Daily zonal mean TOMS total column ozone versus time of year at 70°S for the years 1979 through 1987. Heavy line shows the mean for all years, thin solid line shows 1987, and dots are daily values for all years 1979–1986 (normalized TOMS data used).

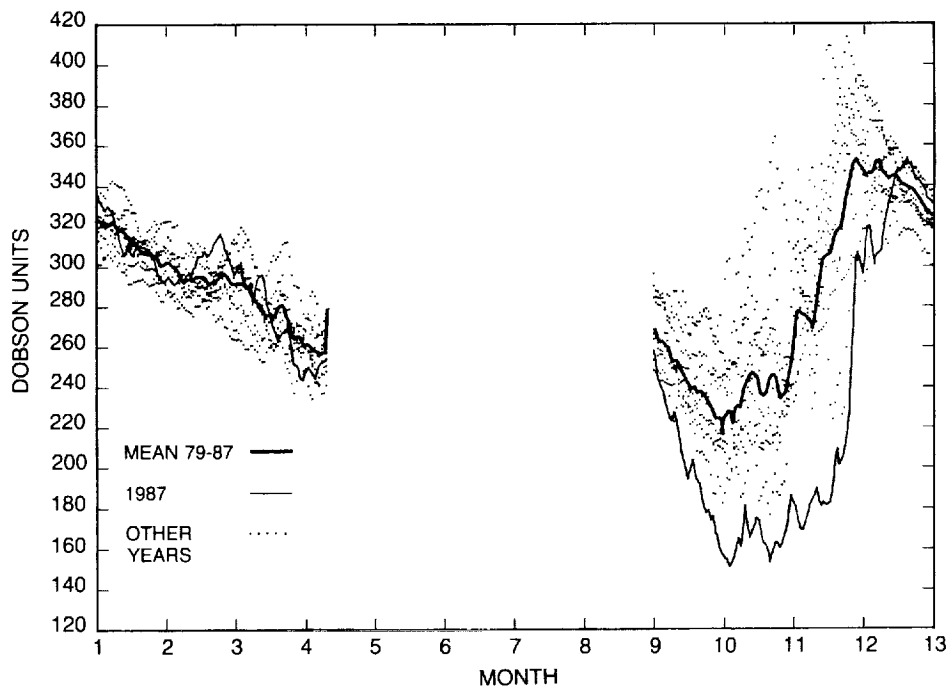

Figure 11.11. Daily zonal mean TOMS total column ozone versus time of year at 80°S for the years 1979 through 1987. Heavy line shows the mean for all years, thin solid line shows 1987, and dots are daily values for all years 1979–1986 (normalized TOMS data used).

ANTARCTIC OZONE CHANGES

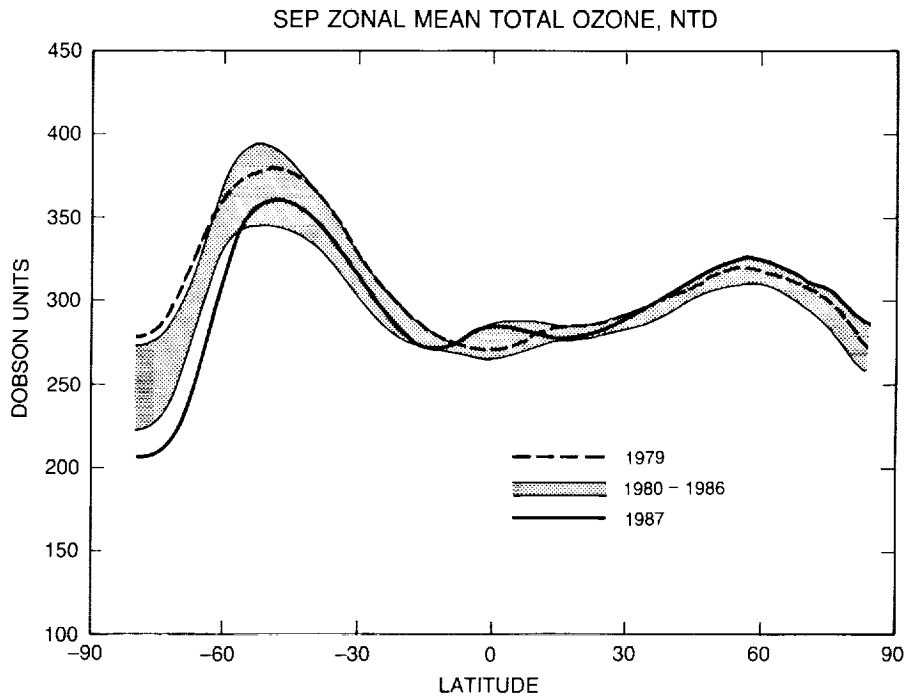

Figure 11.12. Zonally averaged TOMS ozone plotted versus latitude for the month of September from 1979 through 1987, highlighting 1979 with dashed lines and 1987 with a thick black line (normalized TOMS data used). (Schoeberl, 1987, private communication.)

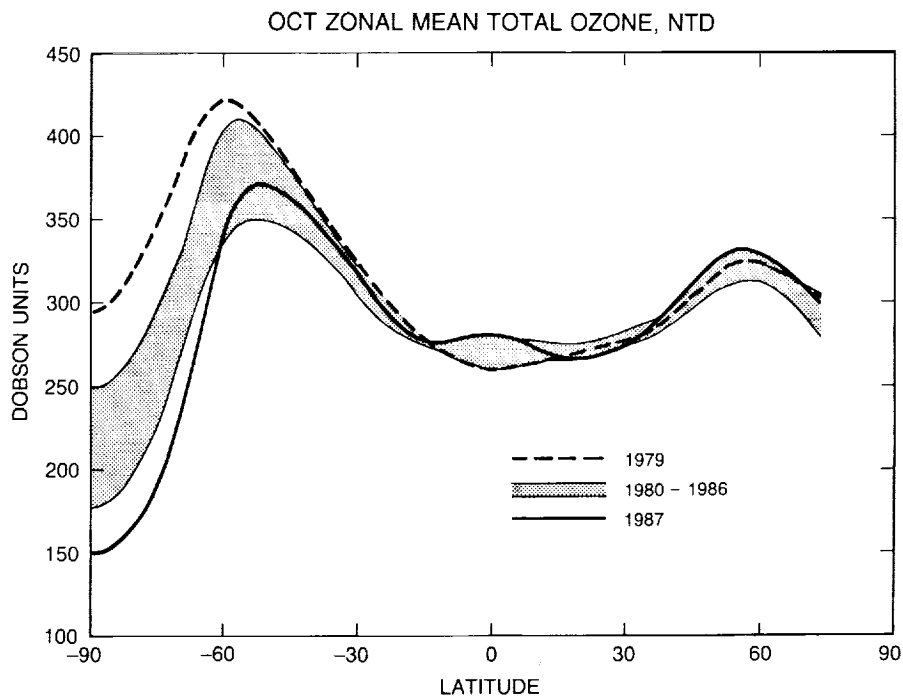

Figure 11.13. Zonally averaged TOMS ozone plotted versus latitude for the month of October from 1979 through 1987, highlighting 1979 with dashed lines and 1987 with a thick black line (normalized TOMS data used). (Schoeberl, 1987, private communication.)

ANTARCTIC OZONE CHANGES

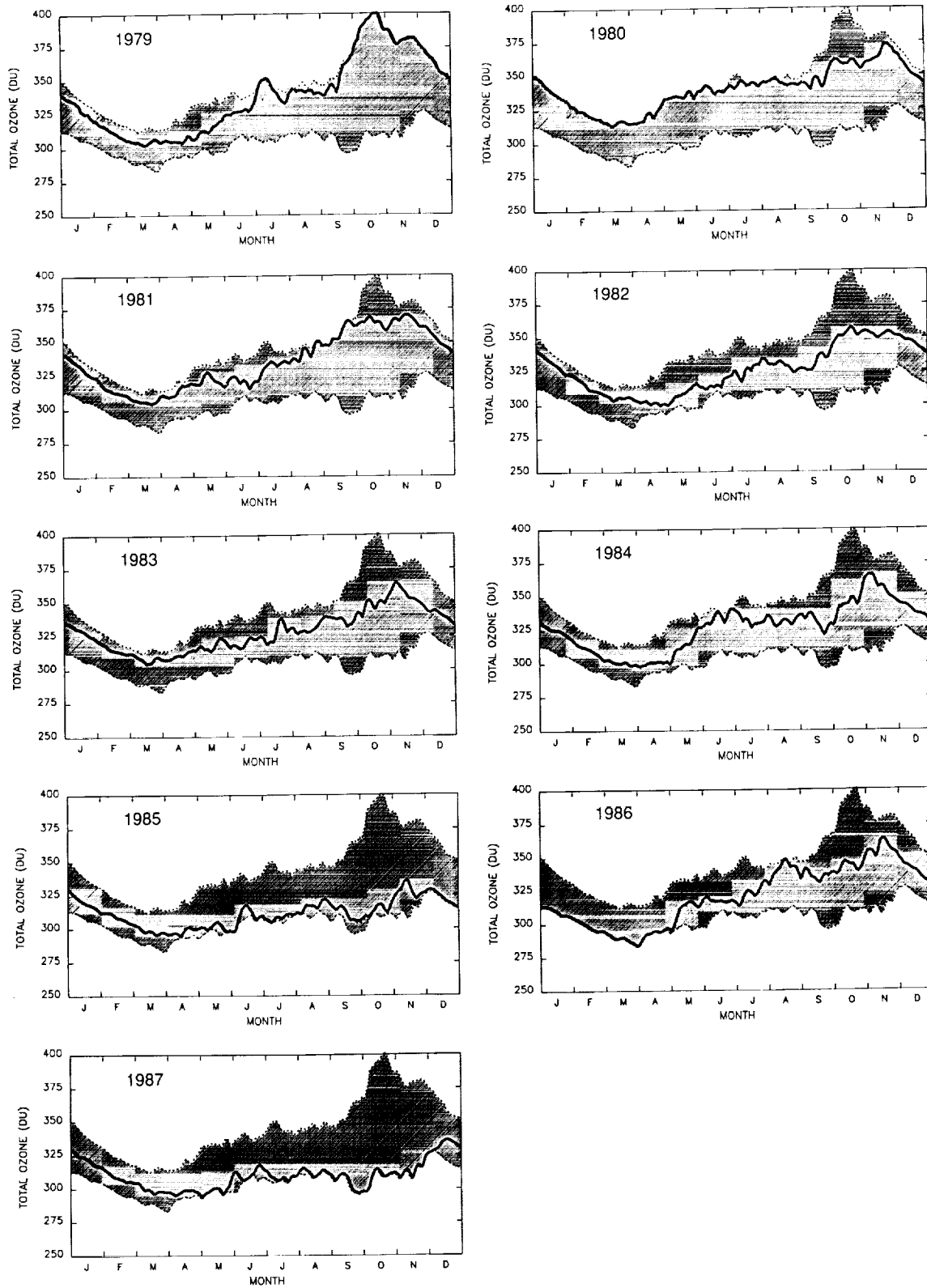

Figure 11.14. Annual progression of TOMS total ozone integrated over the area from 90°S to 44°S plotted for each year from 1979 through 1987. Range of all years is shown as shaded area; solid line in each panel compares individual year to range (normalized TOMS data used). (Schoeberl, 1987, private communication.)

ANTARCTIC OZONE CHANGES

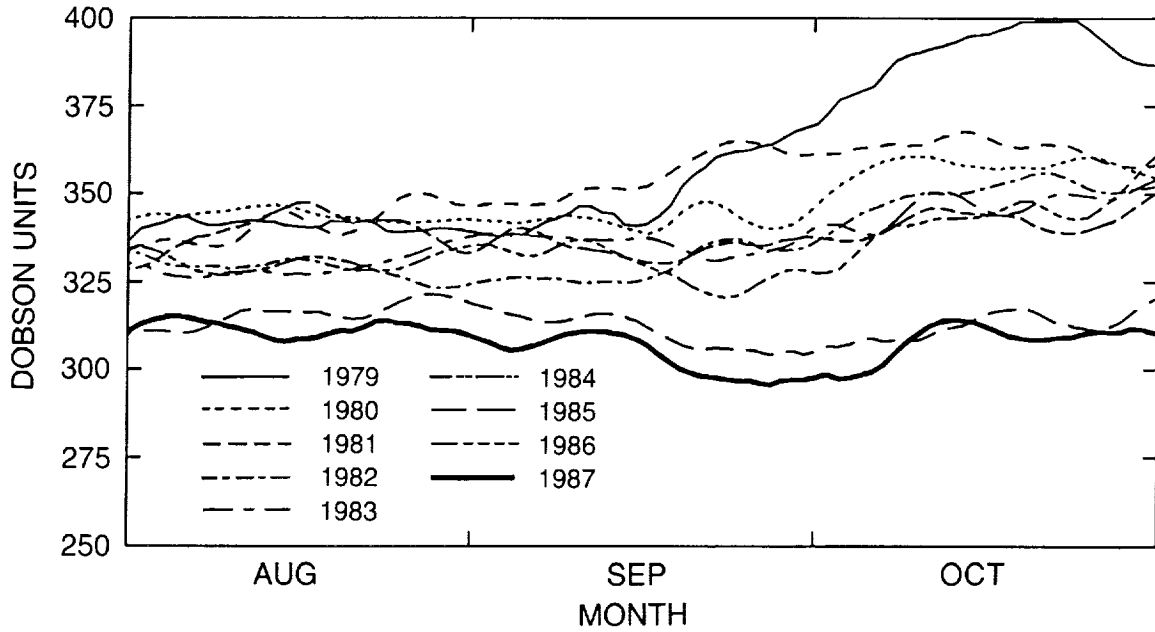

Figure 11.15. Progression of TOMS total ozone integrated over the area from 44°S to 90°S from August through October plotted for each year from 1979 through 1987 (normalized TOMS data used). (Schoeberl, 1987, private communication.)

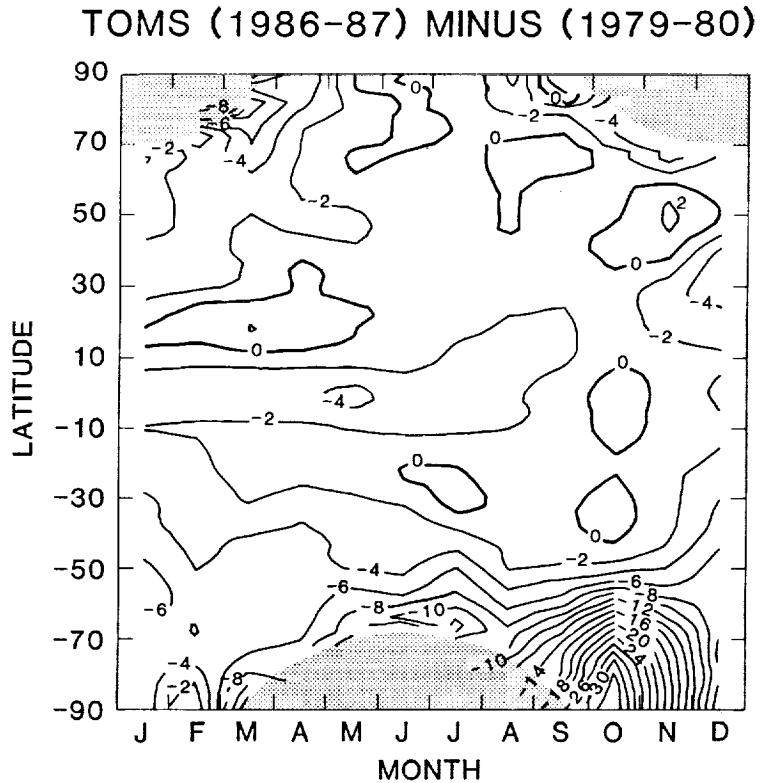

Figure 11.16. Difference between recent 2 years (1986–1987) of TOMS total ozone measurements and first 2 years (1979–1980) as a function of latitude and season. Two years are used to approximately remove the quasi-biennial oscillation.

The development of the minimum occurs mainly during September (Stolarski et al., 1986) when the Sun rises over the polar region. Figures 11.7 and 11.8 clearly demonstrate that the ozone minimum has developed primarily during September in all years since 1979. This behavior has been confirmed by data from McMurdo in Antarctica (Mount et al., 1987; Hofmann et al., 1989) and from the South Pole (Komhyr et al., 1988b). Examination of Figure 11.8 strongly suggests that the rate of ozone decrease during September, within a given year at 80°S, has increased from 1979 to the present. Figure 11.7 is inconclusive as to whether the rate of decrease within a given year of the zonal mean total ozone at 70°S during the late August–September period has increased since 1979. Zonal mean values of ozone at 80°S represent the region of maximum ozone loss—i.e., the ozone hole; hence, Figure 11.8 represents the rate of change of ozone within the region of low ozone. In contrast, the zonal mean values of ozone at 70°S represent a mixture of ozone both within and outside the region of low ozone.

Figures 11.7 and 11.8 also indicate that the period of ozone destruction has lengthened into October, and that the breakdown of the polar vortex now occurs later in the year. Figure 11.17 (Stolarski, private communication) shows four Southern Hemisphere daily total ozone maps for October 15, November 15, November 29, and December 5, 1987. These TOMS images clearly show that the ozone hole lasted until late November/early December in 1987. This is the latest that the region of low ozone has broken down since satellite measurements began. In previous years, it broke down by mid-October to early November; in 1985, the year of the previous lowest ozone, the region of low ozone did not break down until mid-November.

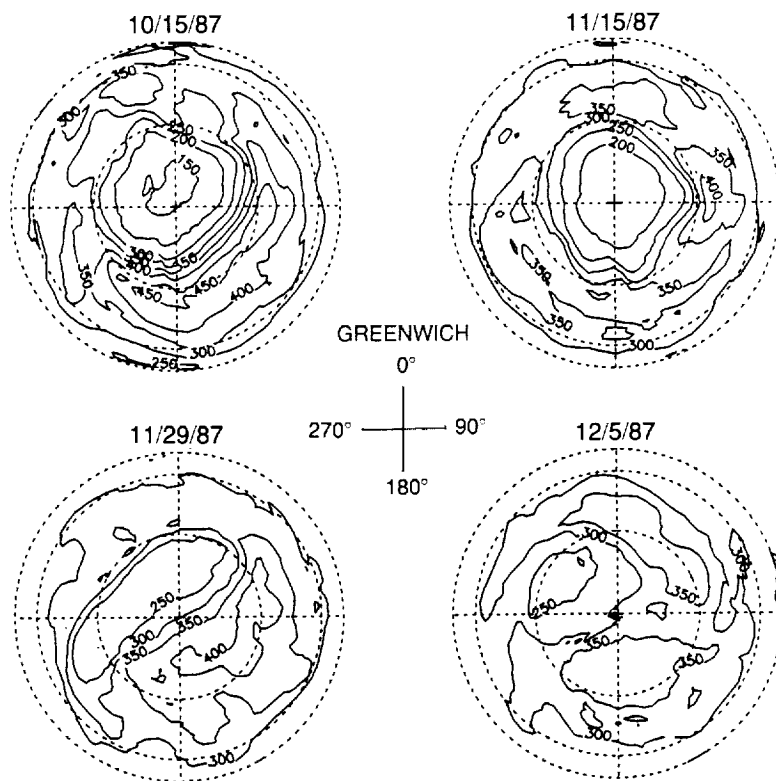

Figure 11.17. Daily TOMS maps of total column ozone in the Southern Hemisphere for October 15, November 15, November 29, and December 5, 1987 (polar orthographic projection). (Stolarski, private communication.)

ANTARCTIC OZONE CHANGES

Figure 11.18 (Stolarski, private communication) shows four Southern Hemisphere daily total ozone maps for August 17, September 5, September 27, and October 5, 1987. These TOMS images clearly show that the abundance of total ozone decreased dramatically over the 6-week period. Total ozone values below 125 DU were observed in early October. However, it is interesting to note that ozone does not change smoothly with time during August, September, and October. In each year since TOMS data have been available, it has been noted that in August and early September, occasional regions appear within the polar vortex where the total ozone content is tens of DU lower than that found in the surrounding area, which is part of the overall polar minimum. In some instances, these "miniholes" formed within 24 hours or less. The miniholes are 5 to 10 degrees in latitudinal and longitudinal extent (an area of several million square kilometers) and last for a few days or more. They seem to occur most frequently in the region just outside the polar night. By mid-September in 1987 they seemed to coalesce into a region of very low total ozone until the minimum was reached in early October. The miniholes are currently thought to be real, even though there is some concern that the amount of ozone they contain is underestimated due to the presence of high cirrus clouds that are always associated with them. Figure 11.19 (Krueger, private communication) shows four daily Southern Hemisphere total ozone maps for September 3–6, 1987. September 3 and 4, respectively, show a relatively uniform abundance of ozone of about 225 DU around the Antarctic continent. September 5 shows the sudden formation of a region with an ozone abundance of less than 200 DU over the Palmer peninsula, surrounded by this general minimum region with ozone amounts of 225 or more DU. September 6 shows that the minihole has moved over the Weddell Sea. The mechanism forming miniholes has yet to be established, and their role and importance in the formation of the ozone hole phenomenon have yet to be determined.

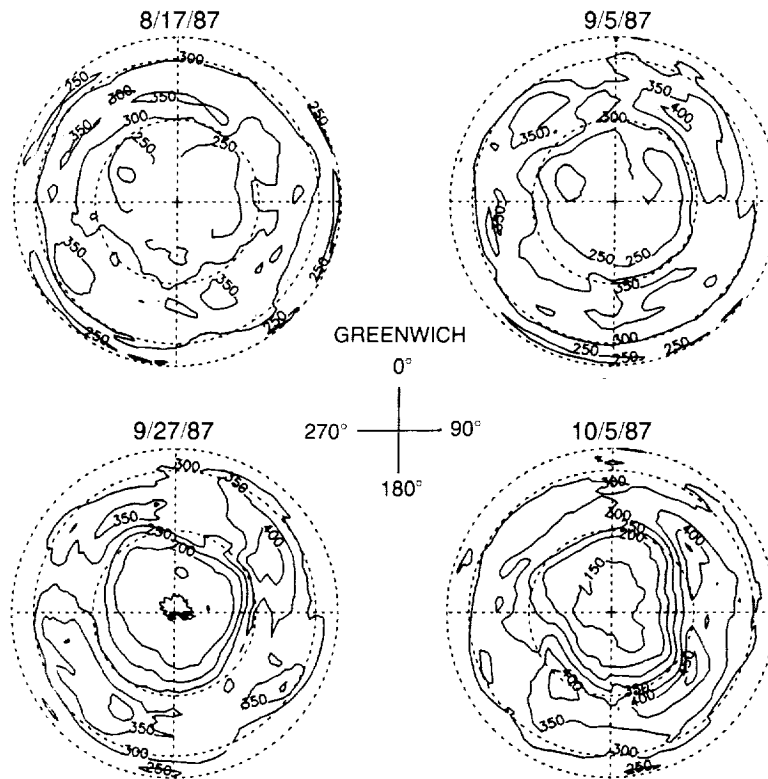

Figure 11.18. TOMS maps of total column ozone in the Southern Hemisphere for August 17, September 5, September 27, and October 5, 1987. (Stolarski, private communication.)

NIMBUS-7: TOMS TOTAL OZONE

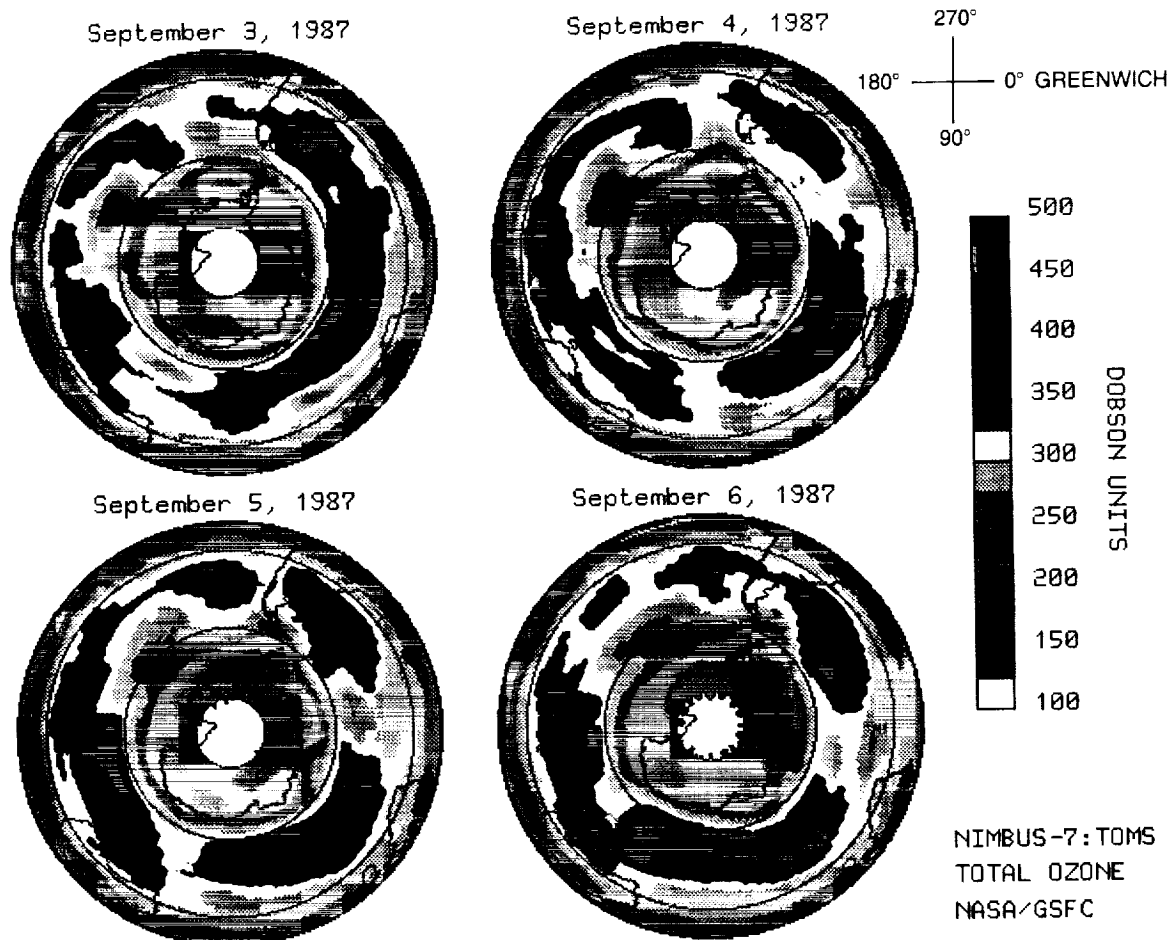

Figure 11.19. TOMS maps of total column ozone in the Southern Hemisphere for September 3–6, 1987. (Krueger, private communication.)

The phenomenology of the formation of the total ozone minimum region is beginning to be described in more detail. The circumpolar maximum ring of total ozone is present throughout most of the year. In fall and winter, it surrounds a region of lower total ozone, although the contrast between maximum and minimum total ozone amounts is only about 50 DU. During winter, the contrast between maximum and minimum values increases until an extreme is reached in October, with nearly a 200 DU difference. This general pattern appears to have existed before the appearance of the extreme low October values (London et al., 1976), but the contrast between maximum and minimum values has now increased in the springtime.

11.2.1.2 Altitude Dependence of Changes in Ozone

The first observations of the vertical extent of the depletion of ozone above Antarctica were reported by Chubachi (1984) based on ozonesonde soundings from Syowa. Ozonesonde observations were made from Syowa (Antarctica) from 1966 to 1972, beginning again in 1982. Figure 11.20 shows the vertical distribution of ozone from July through November for 1970 and 1982. From these observations it is clear that ozone was lower in 1982 than in 1970 between about 40

ANTARCTIC OZONE CHANGES

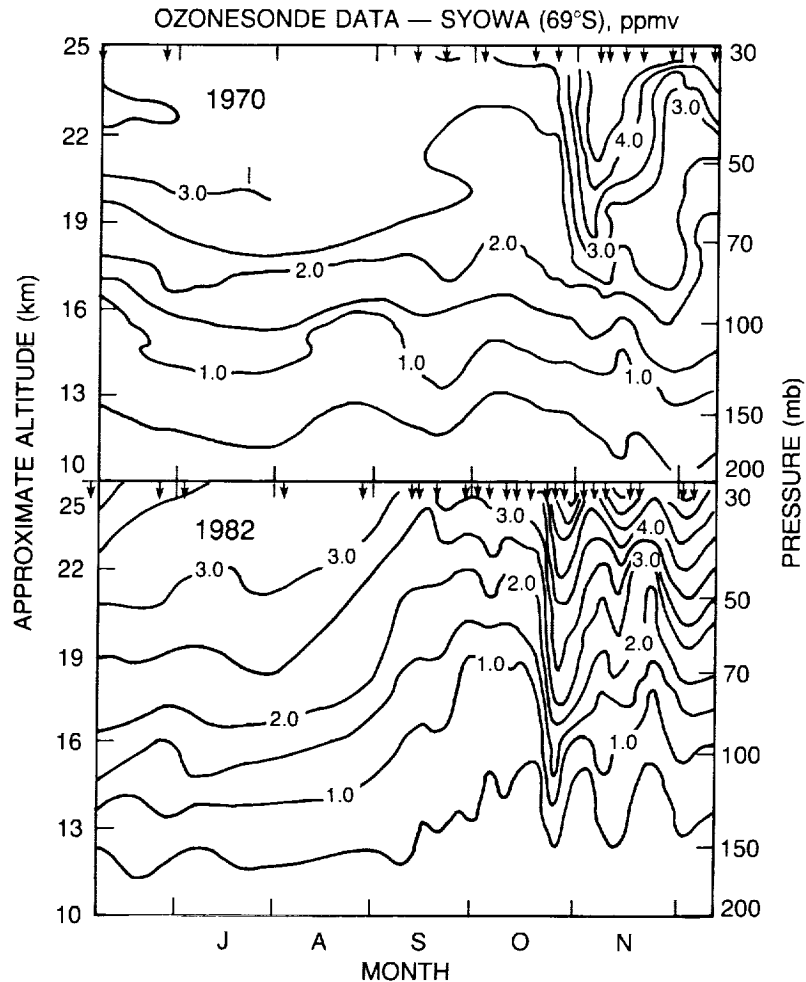

Figure 11.20. Vertical distribution of ozone over Syowa measured by ozonesonde from July through November. Arrows indicate ozonesonde launches during the two time periods. Upper panel shows data for 1970, lower panel for 1982. (Chubachi, 1984.)

and 150 mb, corresponding to about 20 and 13 km, respectively. These findings have largely been confirmed by ozonesonde observations from other stations in Antarctica, including McMurdo (78°S, 146°E) (Hofmann et al., 1986, 1987a, and 1989); Halley Bay (Farman and Gardiner, 1987); Palmer (64°S, 72°W) (Torres and Brothers, 1988); and South Pole (Komhyr et al., 1988b); at the GDR research base near the Soviet station, Novolazarevskaya (71°S, 12°E) (Gernandt, 1987); and by SAGE satellite observations (McCormick and Larsen 1986). The exact altitude range of the ozone depletion varies somewhat between studies. Iwasaka and Kondoh (1987) reported that the ozone decrease extended between 10 and 25 km over Syowa. Hofmann et al. (1986, 1987a) reported the depletion to be confined to a region from about 12 to 22 km above McMurdo in 1986. However, Hofmann et al. (1989), Gardiner (1988), and Torres and Brothers (1988) reported that the region of depleted ozone extended as high as 24 km in 1987.

Balloonsonde observations from McMurdo in 1986 indicated that the minimum began to form in early September near 20–22 km altitude and then to move downward until low ozone was observed from about 12–22 km (Hofmann et al., 1986). Stolarski (1988) has suggested that it is not

clear whether this is a true indication of the time behavior of the process or just an indication of a phase change with altitude that tilts toward the east, such that the high-altitude part of the minimum comes over McMurdo first. However, examination of ozonesonde data from other stations such as Syowa (Solomon, 1988), South Pole (Solomon, private communication), and Halley Bay (Jones, private communication) shows that this behavior is observed at all stations; hence, it appears to be a true indication of the temporal behavior of the phenomena. Figure 11.21, from Hofmann et al. (1986), shows the ozone partial pressure as a function of altitude over McMurdo on August 28, 1986, and that measured on October 16, 1986. The difference is seen to be confined mainly to the region between about 10 and 22 km altitude. As stated earlier, this behavior is confirmed by the balloonsonde measurements at the South Pole (Komhyr et al., 1988b). Figure 11.23 from Komhyr et al. (1988a) shows a pair of profiles from the South Pole for August 9, 1986, and for October 7, 1986. At the left of Figure 11.22, these profiles are compared as ozone partial pressures, and at the right as mixing ratios. Connor et al. (1987) reported ozone decreases up to an altitude of 25 km at McMurdo in 1986 using ground-based millimeter-wave spectrometry. Whether there is any significant discrepancy between the ozonesonde and millimeter-wave data is unclear given that the vertical resolution of the latter technique is approximately one scale height, i.e., about 7 km, and that smearing associated with their weighting functions possibly could account for the reported changes at 25 km.

Figure 11.23 shows the vertical distribution of ozone above Halley Bay on August 15, 1987, and October 15, 1987, showing an almost complete loss of ozone between 40 and 100 mb, i.e., 20

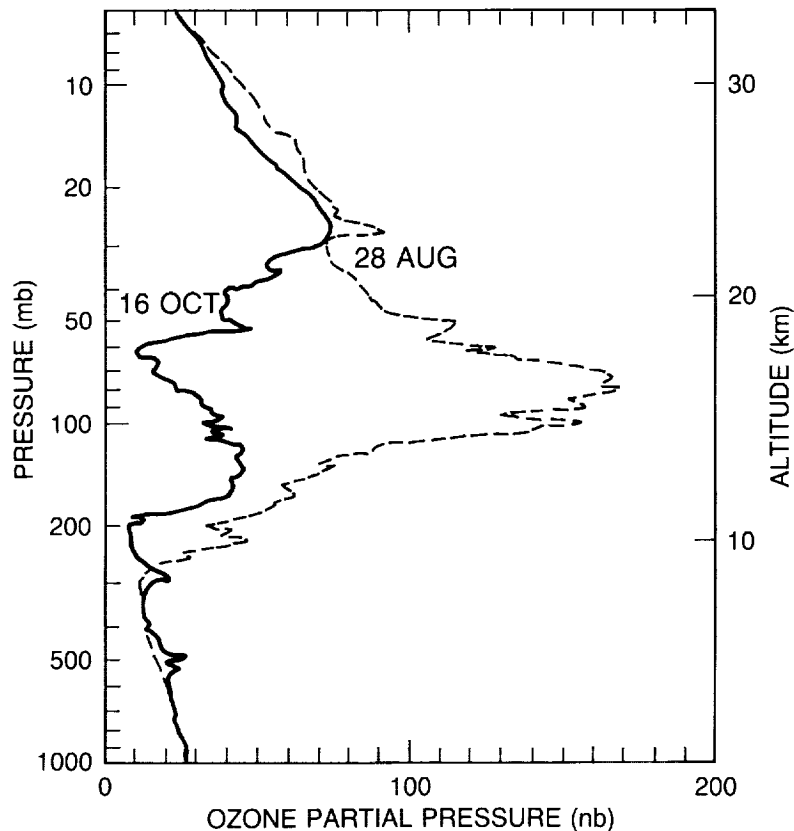

Figure 11.21. Ozone partial pressure as function of altitude over McMurdo as measured by ozonesonde (Hofmann et al., 1986). Shown are August 28 and October 16, 1986.

ANTARCTIC OZONE CHANGES

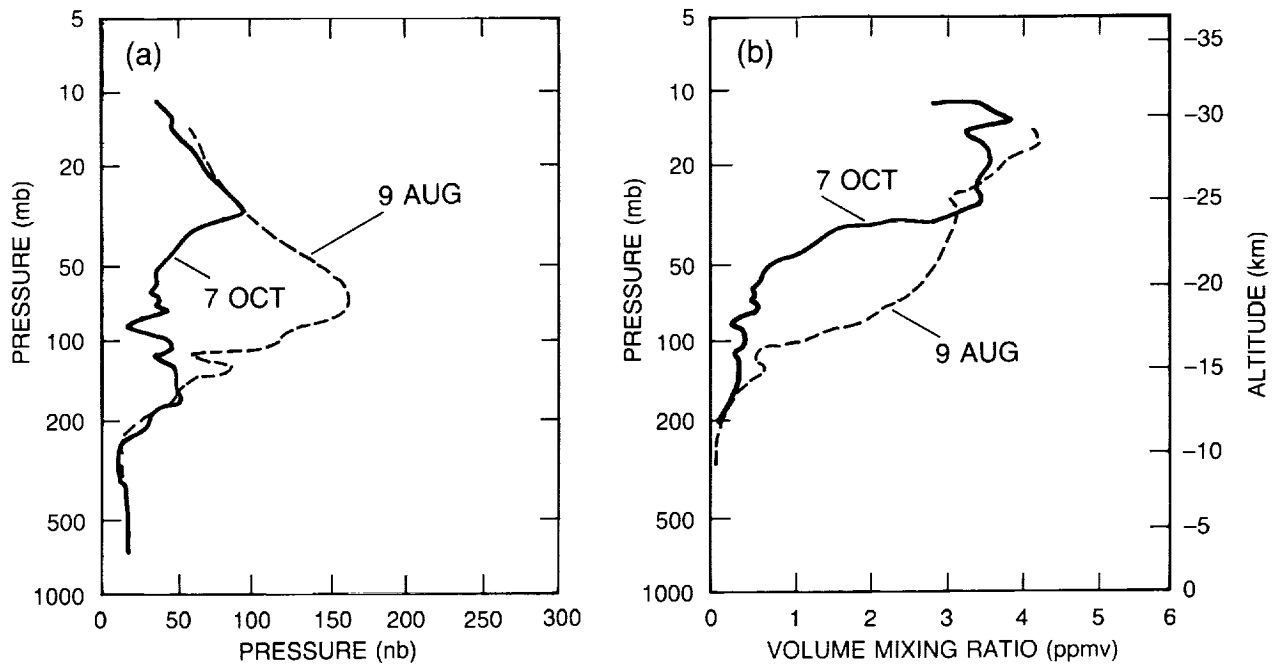

Figure 11.22. Ozone profiles over South Pole measured by ozonesonde for August 9 and October 7, 1986 (Komhyr et al., 1988a). Left panel shows partial pressure; right panel shows mixing ratio.

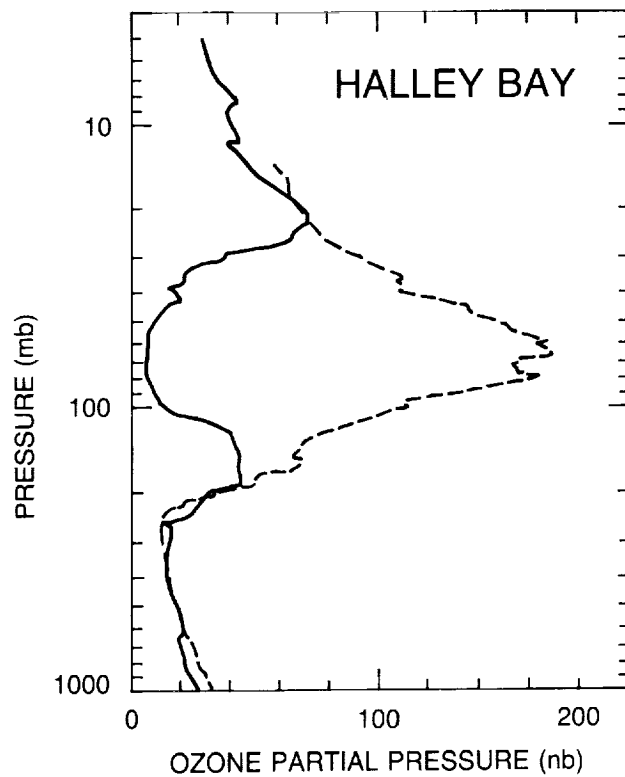

Figure 11.23. Vertical distribution of the ozone partial pressure (nbar) observed at Halley Bay Station on August 15, 1987 (high values), and October 15, 1987 (low values), respectively. (Farman, personal communication, 1987.)

and 15 km. Figure 11.24 shows the vertical distribution of ozone above the Palmer station on October 6, 1987 (high values), and October 9, 1987 (low values), indicating that when the chemically perturbed region of low ozone moves over the Palmer station, the magnitude of the ozone loss is similar to that observed at other stations. Similar results have been reported by Hofmann et al. (1989), Figure 11.25, from McMurdo, and Komhyr et al. (1988b) from the South Pole. Figure 11.26 shows a comparison of SAGE-II and Halley Bay ozonesonde data for October 7, 1987, indicating extremely low values of ozone centered around 75 mb. The 1987 satellite and balloonsonde data clearly indicate that ozone was almost completely removed between 40 and 100 mb, a 5 km altitude region centered near 15 km, and that the altitude region over which ozone decreased ranged from about 14 to 24 km.

During August and September 1987, a campaign was conducted from Punta Arenas, Chile, using a DC-8 and an ER-2 aircraft. The upward-looking lidar aboard the DC-8 of E. Browell and coworkers observed more than a 50 percent decrease in ozone from 14 to 19 km during September 1987 between 77°S and 90°S, but no discernable trend between 12 and 14 km. There was also evidence from the lidar data of a decrease in ozone up to 23 km. The in situ ozone measurements aboard the ER-2 also showed a 50 percent decrease near 18 km during September.

Aikin and McPeters (1986), using SBUV data, reported that the ozone depletion extended up to 1 mb over Antarctica. McCormick and Larsen (1986), using SAGE-I/II data, reported no evidence for a trend in Antarctic springtime ozone above 30 km since 1979, when SAGE-I started to return data.

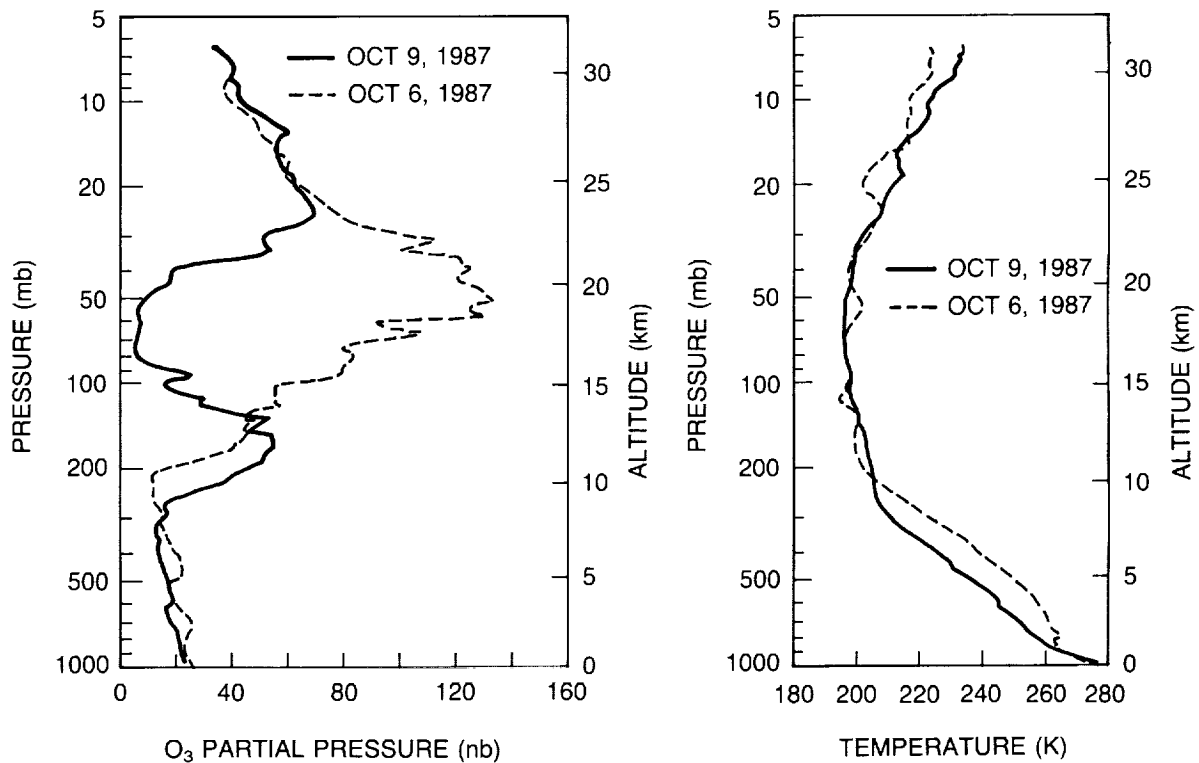

Figure 11.24. (a) Ozone partial pressure over Palmer station on October 6 and 9, 1987; (b) temperature profile for October 6 and 9, 1987, over Palmer Station.

ANTARCTIC OZONE CHANGES

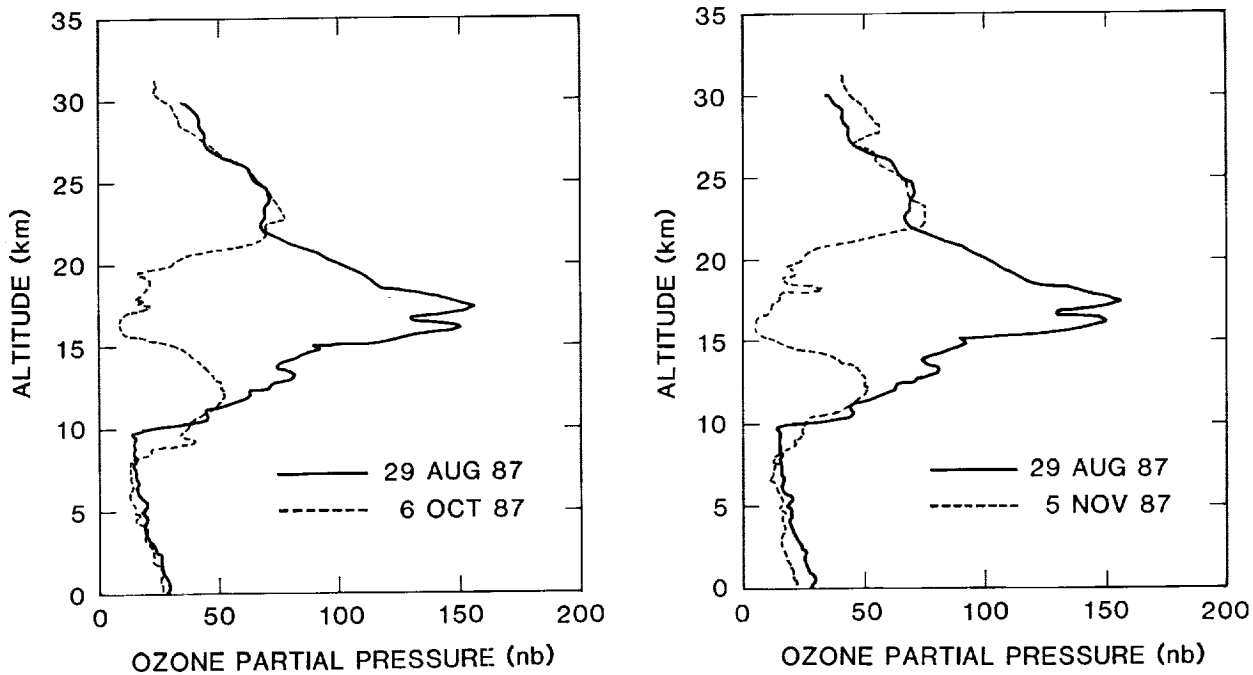

Figure 11.25. Ozone partial pressure over McMurdo measured by ozonesonde (Hofmann et al., 1989); (a) comparison of August 29, 1987, to October 6, 1987, and (b) comparison of August 29, 1987, to November 5, 1987.

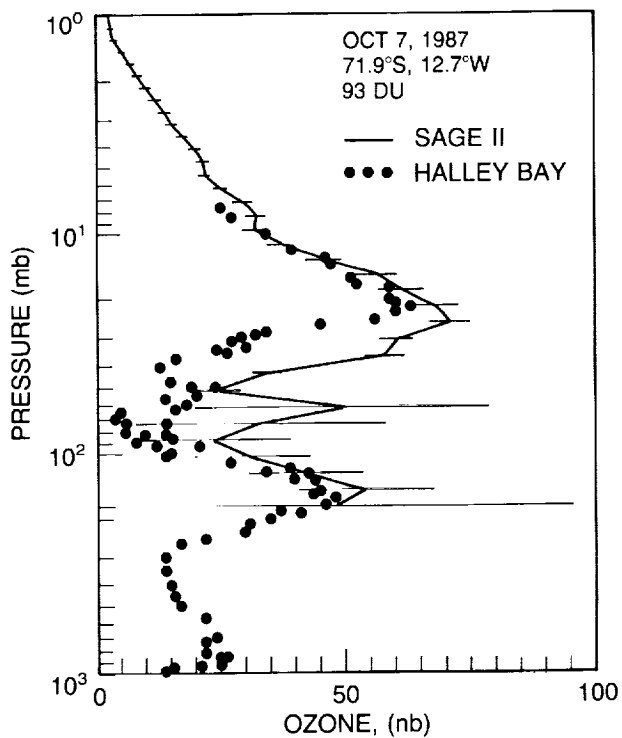

Figure 11.26. Comparison of ozone profiles measured by SAGE with Halley Bay ozonesondes for October 7, 1987. Solid line represents SAGE-II data; dots are ozonesonde data.

One interesting observation is that the 1986 balloonsonde ozone data at McMurdo (Hofmann et al., 1986) show a great deal of structure, primarily in October—i.e., thin layers of less than 1 km thickness in altitude. Figure 11.27, from Hofmann et al. (1986), shows that the vertical distribution of ozone exhibited significant layering and day-to-day variability above McMurdo in 1986. In contrast, the South Pole data show significantly less vertical structure (Komhyr et al., 1988b). Because McMurdo was located near the steep gradient in total ozone for much of the 1986 measurement period, the existence of these layers should not be surprising. They have been measured in previous instances in the Northern Hemisphere (Dütsch, 1974), and are presumably caused by differential advection of air masses with different amounts of ozone.

11.2.1.3 Summary of Ozone Observations

The total ozone changes over high southern latitudes in spring have been measured by several different techniques from the ground and from satellites. The results corroborate one another, providing a clear picture of the changes that have taken place: the development of the minimum occurs mainly during September; the rate of change of ozone within a given Antarctic spring appears to be increasing; the ozone was lower in 1987 than in any previous year since measurements began; the region of low ozone lasted until late November/early December in 1987; the depletion extends to about 50°S; and while the ozone depletion is largest in the Antarctic spring, ozone has decreased at all latitudes south of 50°S throughout the year.

The altitude profiling by balloonborne ozonesondes has shown similar features at a number of stations and is consistent with the SAGE results, providing confidence in their robustness. The ozonesonde and SAGE data seem to indicate that the ozone decrease is confined to a region between about 12 and 24 km.

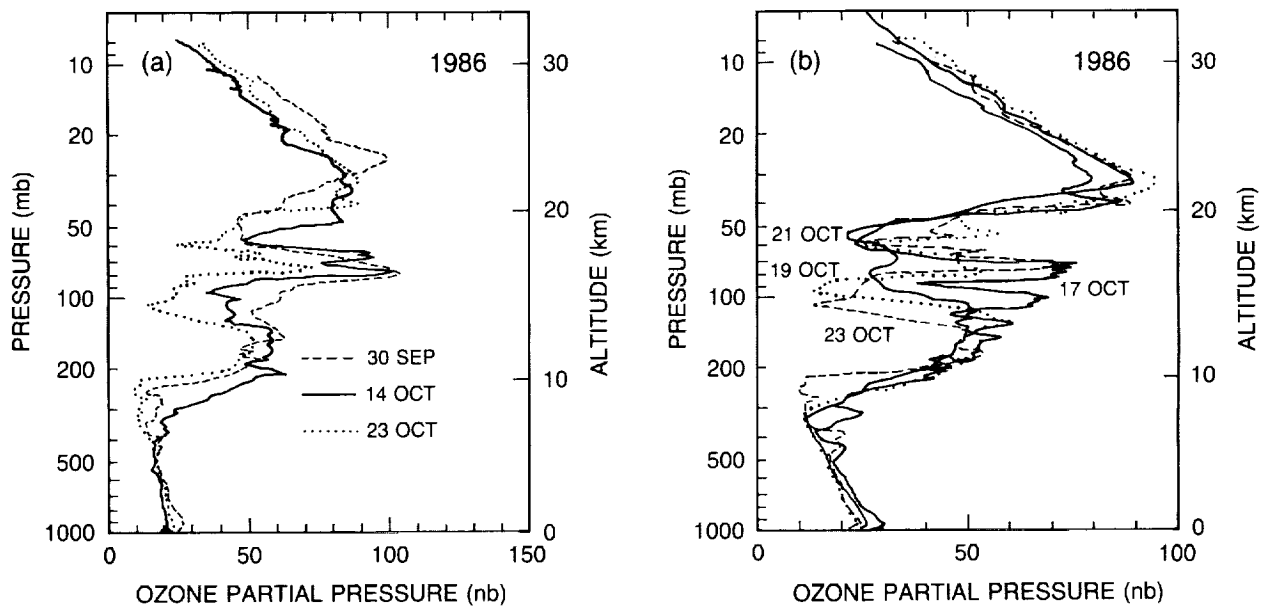

Figure 11.27. Ozonesonde partial pressure measurements for several days over McMurdo during 1986 (Hofmann et al., 1986).

ANTARCTIC OZONE CHANGES

11.2.2 Morphology of Polar Stratospheric Clouds

This section briefly treats Polar Stratospheric Clouds (PSC's), which are discussed in more detail in Chapter 10. Remote-sensing measurements made by the satellite sensor SAM-II, starting in late 1978, have shown that stratospheric clouds occur in both winter polar regions more frequently than had been realized by earlier visual sightings. Named Polar Stratospheric Clouds (McCormick et al., 1982), they were found not to be confined only to the lee side of mountain ranges, but to be strongly associated with synoptic-scale regions of very cold stratospheric temperatures. The first idea put forth to describe the initial data was that the clouds probably formed as a result of the deposition of water vapor onto preexisting stratospheric aerosol droplets (made of sulfuric acid and water) at temperatures below the frost point. Recent studies have proposed that PSC's form by the coupled deposition of nitric acid and water vapors, rather than by the deposition of water vapor alone (McElroy et al., 1986a; Toon et al., 1986; Crutzen and Arnold, 1986). This scenario suggests a possible chemical link between PSC's and the ozone hole. Figure 11.28, from McCormick and Trepte (1987), shows the SAM-II weekly averaged polar stratospheric optical depth record at $1 \mu\text{m}$ wavelength for October 1978 to December 1986. Both polar regions clearly show that the overall aerosol trend is driven by major volcanic eruptions, which are annotated on the abscissa with their eruption times. The largest increase in this record was caused by the April 1982 eruption of El Chichón. In addition, the Antarctic record clearly shows yearly enhancements in austral winter caused by the presence of PSC's. See, for example, the large order of magnitude enhancement in June–September 1979. This signature is repeated each year, even in the presence of the strong volcanic levels after the El Chichón eruption.

Another feature shown in the Antarctic record of Figure 11.28 is the noticeable minimum occurring each year in October. At this time of the year, the vortex is normally still well formed. Because of the orbit of the Nimbus-7 satellite, SAM-II measurements can be made within the vortex. The minimum indicates that a cleansing has occurred between the pre- and post-PSC period. Subsidence of the air in the altitude region of aerosols and PSC's (10–25 km) is probably not strong enough to cause the observed cleansing over this short period of time, nor is

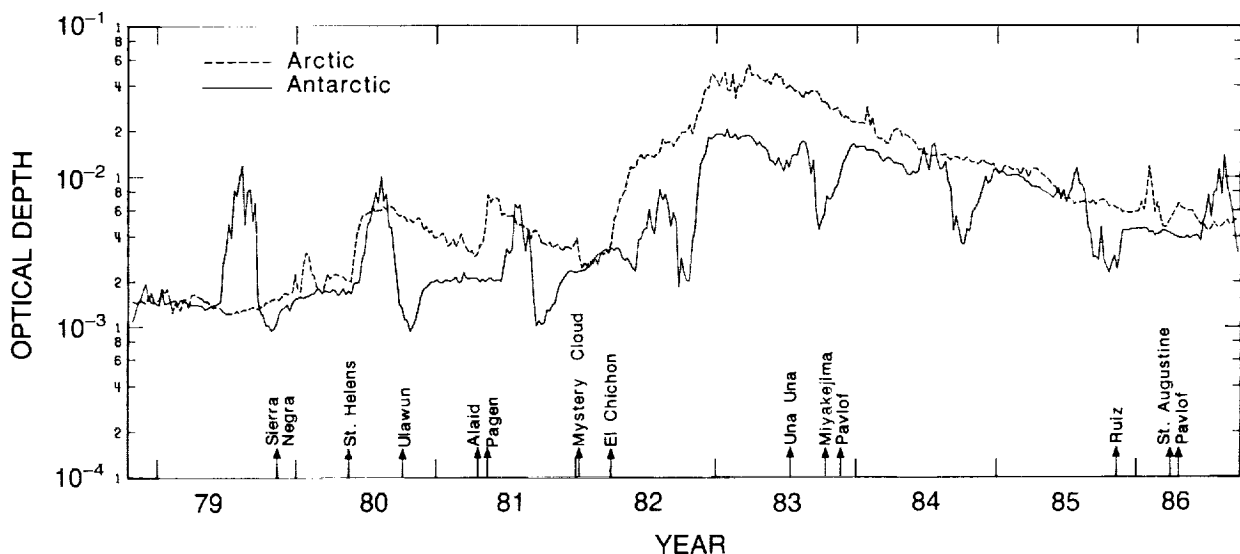

Figure 11.28. SAM-II weekly averaged stratospheric optical depth at $1 \mu\text{m}$ over the Arctic and Antarctic regions from October 1978 to September 1986 (McCormick and Trepte, 1987).

sedimentation of aerosols or PSC's with small diameters (i.e., equal to or less than $1 \mu\text{m}$). However, aerosols or PSC's with larger diameters can sediment at significant rates; for example, a $10 \mu\text{m}$ diameter particle would fall at a rate of 1–2 km per week.

Figure 11.29 shows the SAM-II weekly averaged aerosol extinction ratio (aerosol extinction divided by molecular extinction) for Antarctica as a function of time for 1980, 1982, and 1984

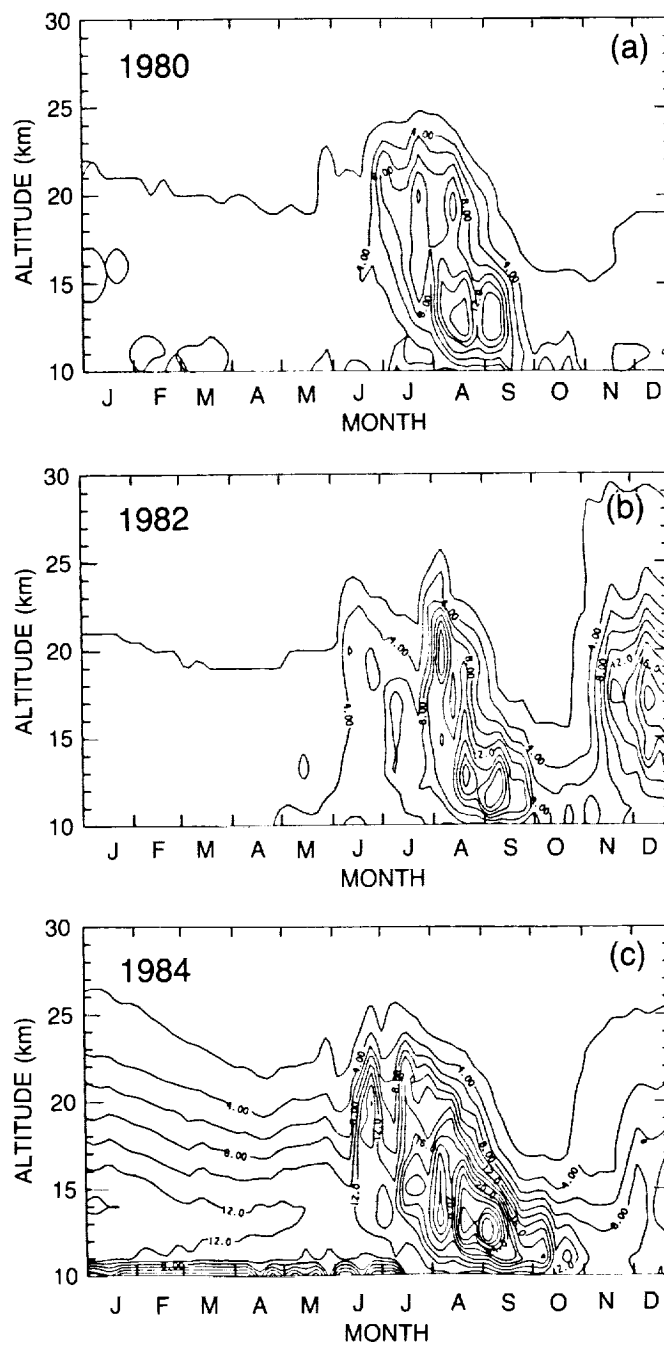

Figure 11.29. Contour plots of SAM-II weekly averaged extinction ratio at $1 \mu\text{m}$ for (a) 1980, (b) 1982, (c) 1984. (McCormick and Trepte, 1986.)

ANTARCTIC OZONE CHANGES

(McCormick and Trepte, 1986). As previously described, it also shows the vertical extent of PSC's correlated with cold temperatures, the cleansing that occurs during each wintertime period, the relative minimum in October, and the large overall increase in stratospheric aerosols in the Southern Hemisphere that started in about November 1982, after the April 1982 eruption of El Chichón. It should be noted that atmospheric temperatures increase during spring, starting at higher altitudes, resulting in a temporal decrease in the maximum altitude at which PSC's can exist.

Iwasaka et al. (1986) reported lidar aerosol data from Syowa indicating that the abundance of PSC's in September and October had increased from 1983 to 1985 along with a decrease in stratospheric temperatures. McCormick (private communication) reports that the persistence of PSC's in Antarctica has increased since 1984. The 1985 observations show for the first time the occurrence of PSC's at 18 km throughout the end of September. Further, PSC's lasted into October in 1987, at altitudes as high as 18 km and 20 km, in sharp contrast to earlier years. Figures 11.30a,b,c,d show the extinction ratio—i.e., aerosol/molecular extinction at $1.0 \mu\text{m}$ —at both 18 km and 20 km for 1979 and 1987. Further analysis of all aerosol data is needed to quantify any changes in the PSC's over Antarctica during the last decade or so.

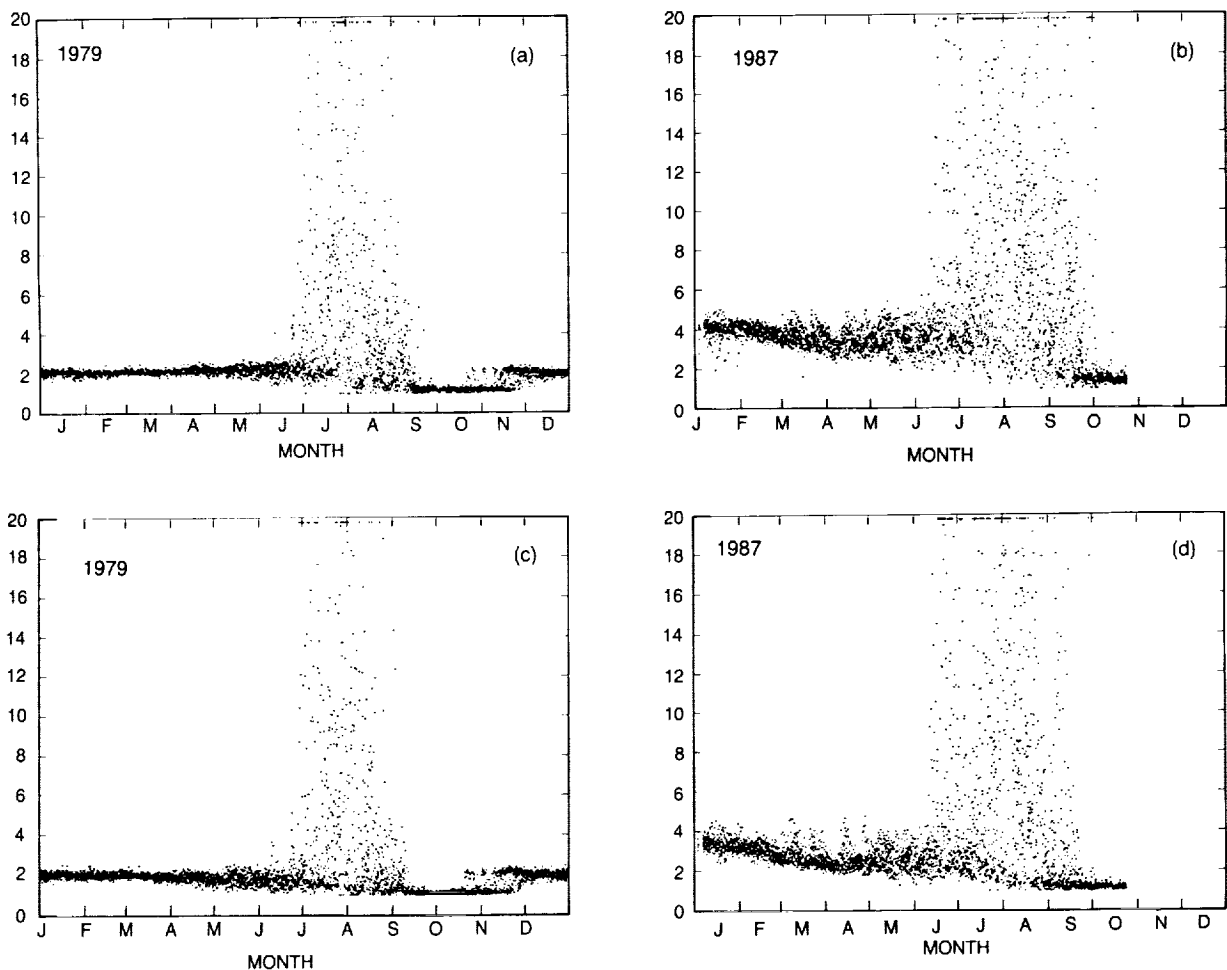

Figure 11.30. SAM-II extinction ratios versus time of year for (a) 1979 at 18 km altitude, (b) 1987 at 18 km altitude, (c) 1979 at 20 km altitude, (d) 1987 at 20 km altitude.

11.2.3 Antarctic Temperature Trends

11.2.3.1 Introduction

Temperature trends that might occur in association with the ozone trends in the south polar region are key in attempting to understand the causes of the observed ozone decline. In the lower stratosphere, both potential temperature and the ozone-mixing ratio have rather long relaxation time scales and both increase with altitude. Therefore, both ozone and temperature tend to decrease locally in response to upward vertical motion and to increase in response to downward motion. Strong correlations between total ozone and dynamical variables such as temperature, geopotential height, and tropopause height are well established in the literature for time scales of days to weeks (e.g., Dobson et al., 1927; Meetham, 1937; Reed, 1950). For periods of at least up to a few weeks, ozone variations associated with vertical motions can be expected to be accompanied by variations in temperature.

Ozone and potential temperature are not perfectly conservative quantities in the lower stratosphere, so that chemical sources of ozone and temperature changes associated with heat transfer by radiation must be considered when the time scale of interest exceeds about a week. A further complication is introduced with the influence of ozone and temperature on each other. Ozone photochemistry is temperature dependent, and ozone itself is a radiatively important constituent in the stratosphere. In the springtime, as the Sun rises over the south polar area, absorption of solar radiation by ozone becomes a principal component of the heat balance in the lower stratosphere.

In this section, evidence for the existence of trends in temperature in the stratosphere over Antarctica will be reviewed. Although monthly averaged temperatures will provide the primary focus, relationships between interannual variability in temperature and total ozone also will be described. The high spatial correlation of the observed changes in total ozone and temperature (which are independent data sets) indicates the generally good precision of the daily global fields. Discussion of what the relationships between ozone and temperature changes might have to say about the cause of the total ozone decline in recent years will be deferred until Section 11.3. General descriptions of the temperature data sets used in this section are given in Chapter 6 (Stratospheric Temperature Trends).

11.2.3.2 Data Intercomparisons

A critical analysis of stratospheric temperature data from a variety of sources shows a greater consistency than previously believed (see Chapter 6). In this section, comparisons between October average U.S. National Meteorological Center (NMC) and radiosonde-observed (RAOB) temperatures are reviewed to document the reliability of these temperature data. In addition, the longer data record available for the RAOB data allows the temperature changes over 1979–1985 to be viewed in the context of the historical record. The quality of temperature retrievals is assessed monthly by NMC. These summaries show mean lower stratospheric daily differences from radiosondes that are generally less than 3 K over Antarctica. Newman and Schoeberl (1986) noted that the NMC October 1979 monthly mean data were underestimations of the radiosondes; this is confirmed in the monthly summaries. The only year in which the NMC data do not give lower temperatures than do the RAOB data is 1982, when the NMC temperatures appear to be higher by about 1 K.

ANTARCTIC OZONE CHANGES

Figure 11.31 (from Newman and Randel, 1988) shows time series of October 100hPa (hecto-Pascals) (1 hPa = 1 mb) temperatures at eight stations around Antarctica, for both NMC (1979–1986) and RAOB (1957–1984) data. These stations were chosen to represent the largest geographical area with the availability of a long time series. Direct comparisons of RAOB to NMC data are available only for 1978–1984, with many of the stations having incomplete records over this period. Nonetheless, the agreement between the two data sets is generally good. Of particular interest is that similar year-to-year changes are observed in both data sets. Figure 11.32 shows similar comparisons at 30hPa; again, overall agreement promotes confidence in the NMC analyses. Although biases are apparent at some stations (such as Casey and Davis in Figure 11.32), comparison of NMC and RAOB data for individual years suggests that the NMC data capture the horizontal temperature structure in the lower-to-middle stratosphere quite accurately. Examples of the horizontal structure of temperature fields are shown in Figure 11.33a,b for October 1983 at 100 and 30hPa. The RAOB temperatures are superimposed for comparison. These are compared to the October 1983 map of TOMS total ozone in Figure 11.33c.

Austin et al. (private communication, 1988) used Microwave Sounding Unit (MSU) channel-24 data to determine lower stratospheric temperature trends. These data provide a measure of temperature in the 50–200hPa region. Using Meeks and Lilley (1963) oxygen transition lines, Newman and Randel (1988) calculated the MSU channel-4 radiances from the

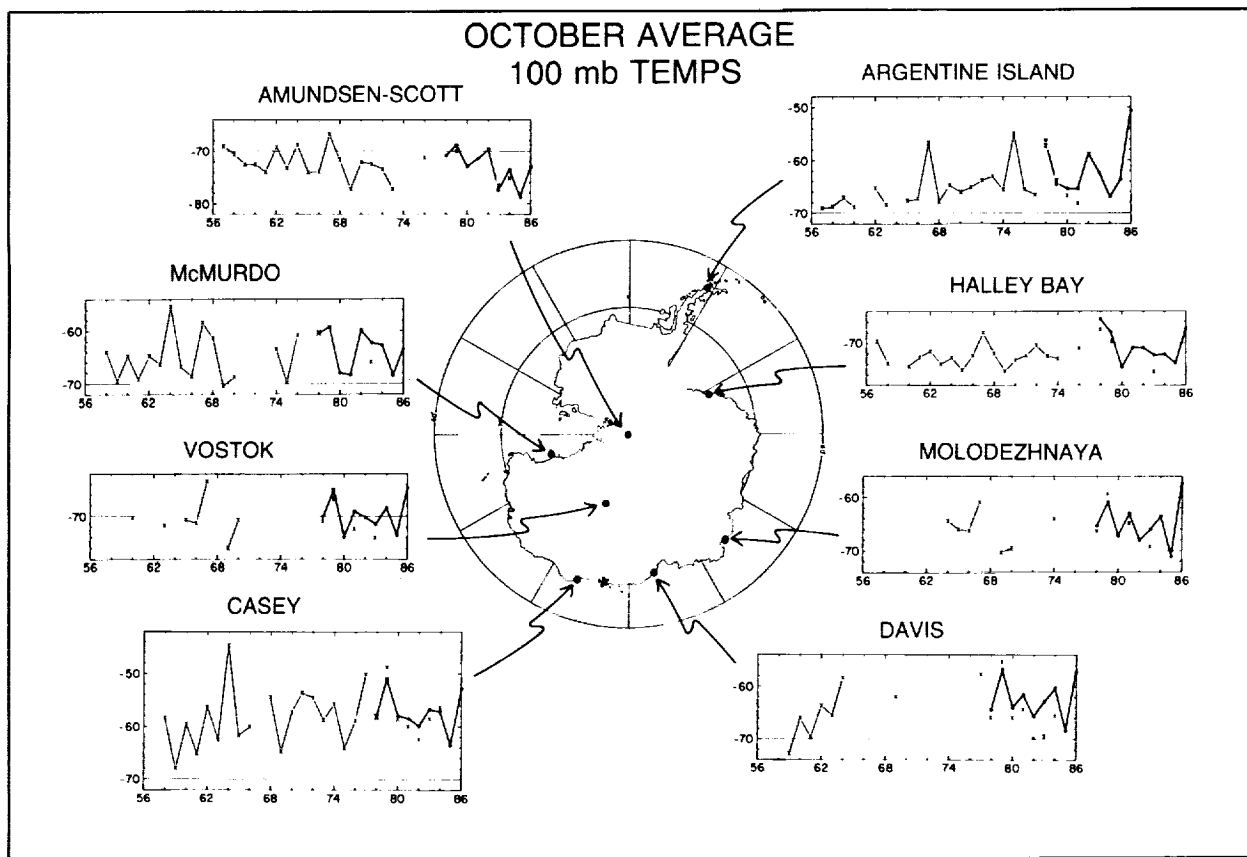

Figure 11.31. Time series of October mean 100 mb (100hPa) temperatures over eight Antarctic stations. Data from 1957–1984 are from rawinsonde observations (RAOB) and data from 1979–1986 are from NMC analyses.

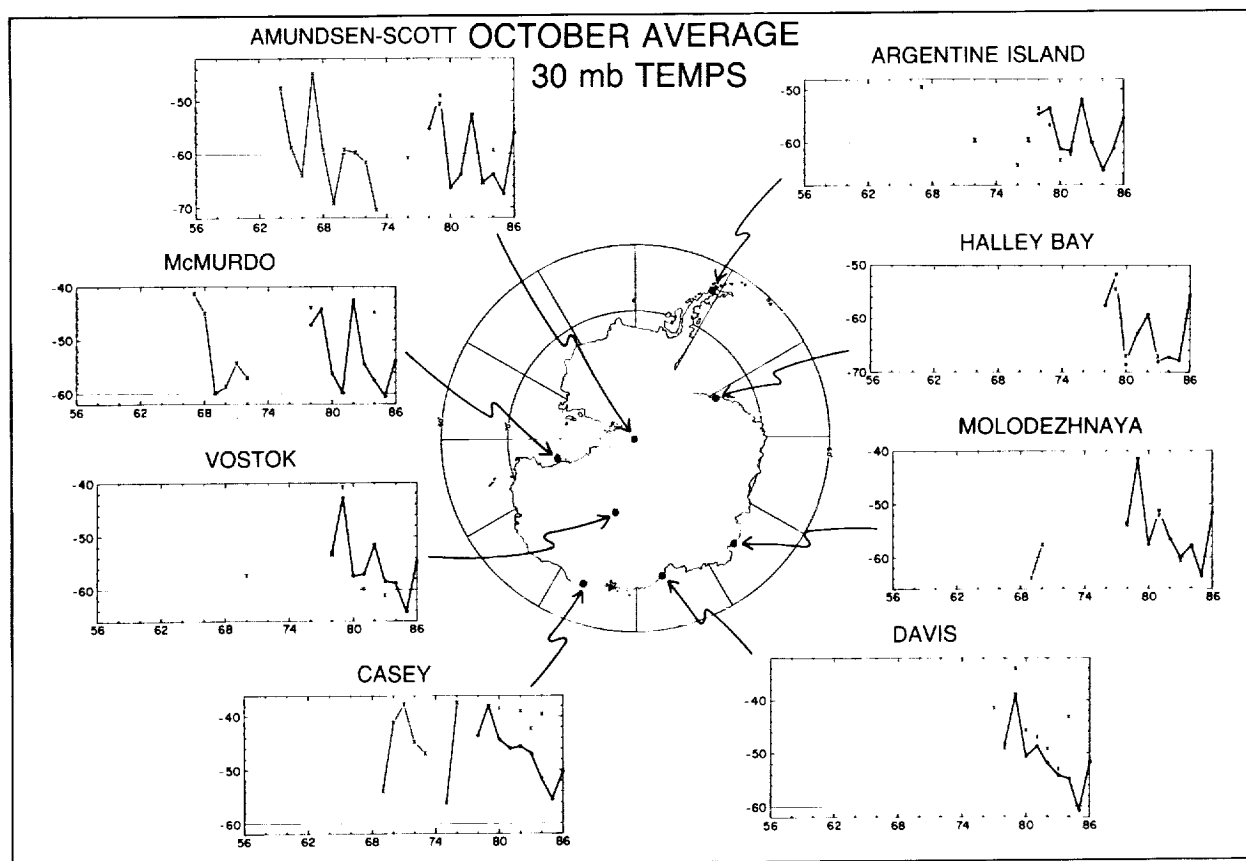

Figure 11.32. Time series of October mean 30 mb (30hPa) temperatures over eight Antarctic stations. Data from 1957–1984 are from rawinsonde observations (RAOB) and data from 1979–1986 are from NMC analyses.

NMC temperature data (see Chapter 6). They found that the MSU radiances simulated from the NMC temperatures were in general agreement, apart from a constant offset. In general, the brightness temperatures from the NMC data were biased 4–7 K higher than the MSU data, either because of the crude weighting function used in the simulation or the poor vertical resolution of the NMC data. The interannual variations of the two data sets match fairly well. The difference between 1979 and 1985 is similar in the two data sets: approximately 8 K in the MSU data and 9.5 K in the NMC data.

Comparison of NMC October 1979 50hPa temperatures to GFDL FGGE* IIIb October 1979 50hPa temperatures (Lau, 1984) shows good agreement. Near the minimum in temperature and ozone, the NMC data were approximately 2 K warmer than the GFDL data, while near the maximum, NMC data were approximately 2 K colder than those from GFDL. In spatial pattern, NMC and GFDL 50hPa temperatures are virtually identical.

One objective of these comparisons is to verify the 1979–1985 temperature changes observed in the NMC data. However, not much RAOB data is available for these later years (Figures 11.31, 11.32, and 11.34). On the other hand, both 1979 and 1983 have numerous reports that make a

*Geophysical Fluid Dynamics Laboratory First GARP (Global Atmospheric Research Program) Global Experiment

ANTARCTIC OZONE CHANGES

a) 1983 100 mb OCTOBER TEMPERATURE

b) 1983 30 mb OCTOBER TEMPERATURE

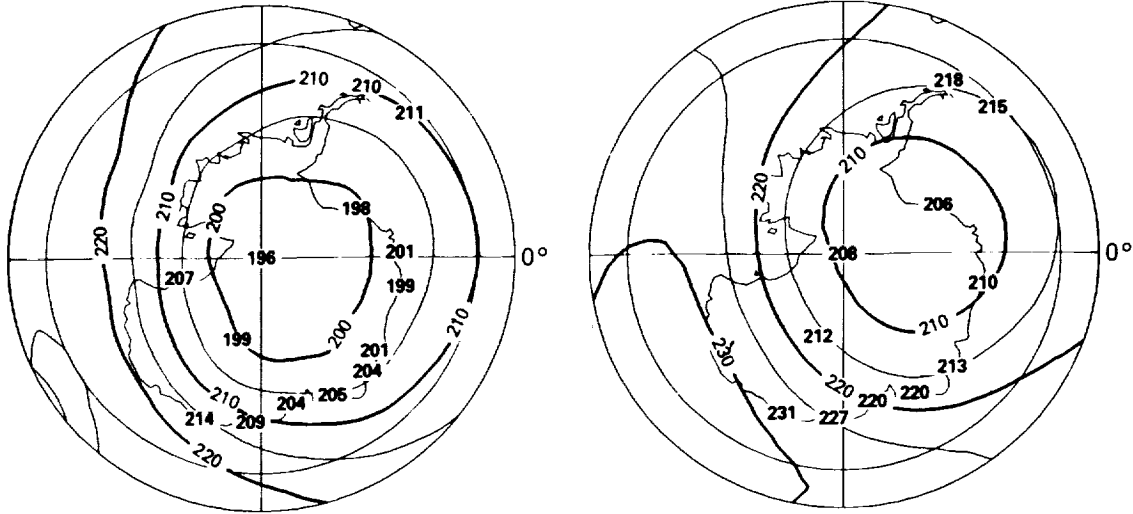

c) 1983 TOMS OCTOBER TOTAL OZONE

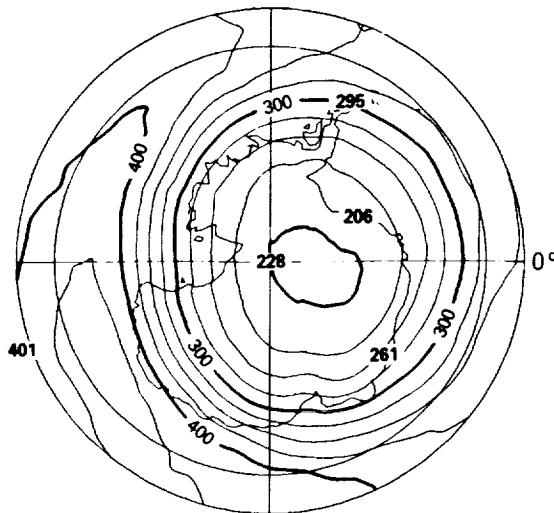

Figure 11.33. October 1983 maps of (a) temperature at 100 mb (hPa), (b) temperature at 30 mb (hPa), and (c) TOMS total ozone. Taken from Newman and Randel (1988).

direct comparison possible. Additionally, the 1983–1979 differences are very similar to the temporal trends calculated for 1979–1986 (Figure 11.35). Figure 11.36 (from Newman and Randel, 1988) shows the NMC-observed 1979–1983 differences over the polar region at 100hPa; superimposed over the station locations are values calculated from RAOB data. The patterns and magnitudes are in good overall agreement, with the NMC differences being smaller on the east coast of Antarctica. A similar comparison is shown in Figure 11.36 for 30hPa, with the 1983–1979 differences showing remarkable consistency between these data sources. Again, the NMC differences are somewhat smaller than the RAOB values over the east coast. Inspection of the individual years suggests that this results from the underestimation of temperatures by the NMC retrieval scheme over this region during the warm southern spring of 1979 (see Figures 11.31, 11.32, and 11.34). The good agreement between NMC and RAOB differences in Figure 11.36

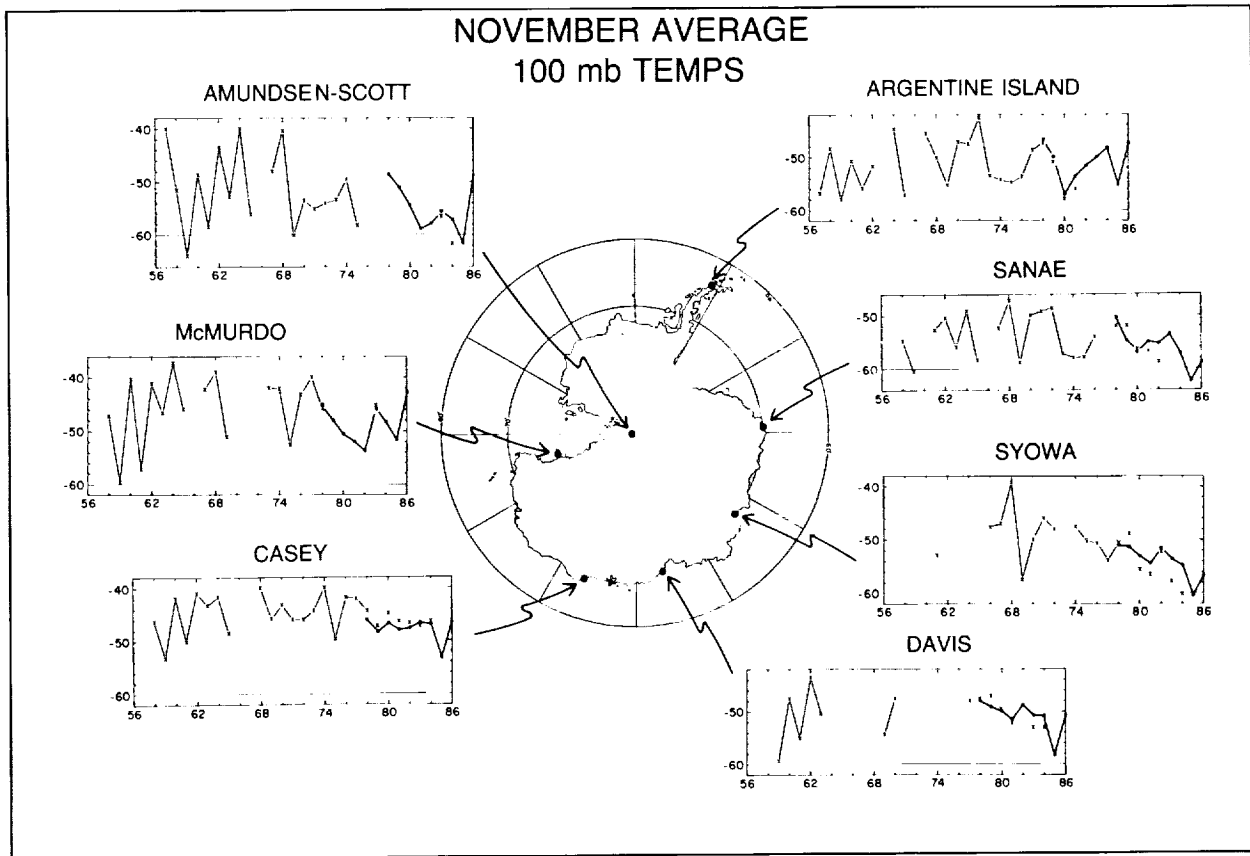

Figure 11.34. Time series of November mean 100 mb (100hPa) temperatures over seven Antarctic stations. Data from 1957–1984 are from rawinsonde observations (RAOB) and data from 1979–1986 are from NMC analyses.

lends confidence to the NMC temperature trends discussed previously. The RAOB's suggest that temperature differences might be slightly larger than those given by NMC values. Note that the highly asymmetric patterns seen in Figure 11.36 clearly caution against the calculation of trends based on values from irregularly spaced station data.

11.2.3.3 Rawinsonde Analyses

In the paper that first announced the recent decline in total ozone over Antarctica, Farman et al. (1985) stated that no corresponding trend in the temperatures at the 100 mb level was measured with rawinsondes over Halley Bay and the Argentine Islands. Sekiguchi (1986) and Chubachi (1986), on the other hand, found a significant recent decline in springtime stratospheric temperatures at Syowa for October and November. Sekiguchi's plots of total ozone and 100hPa temperature, shown in Figure 11.37, suggest that trends in ozone and temperature persist into November and December. The interannual variations of these two quantities are strongly correlated over the 20-year period shown, with 1979 and 1982 appearing as years with relatively high temperatures and ozone in both October and November.

Many authors who have reported declines in south polar stratospheric temperatures in recent years also noted the correspondence with decreasing total ozone (e.g., Sekiguchi, 1986;

ANTARCTIC OZONE CHANGES

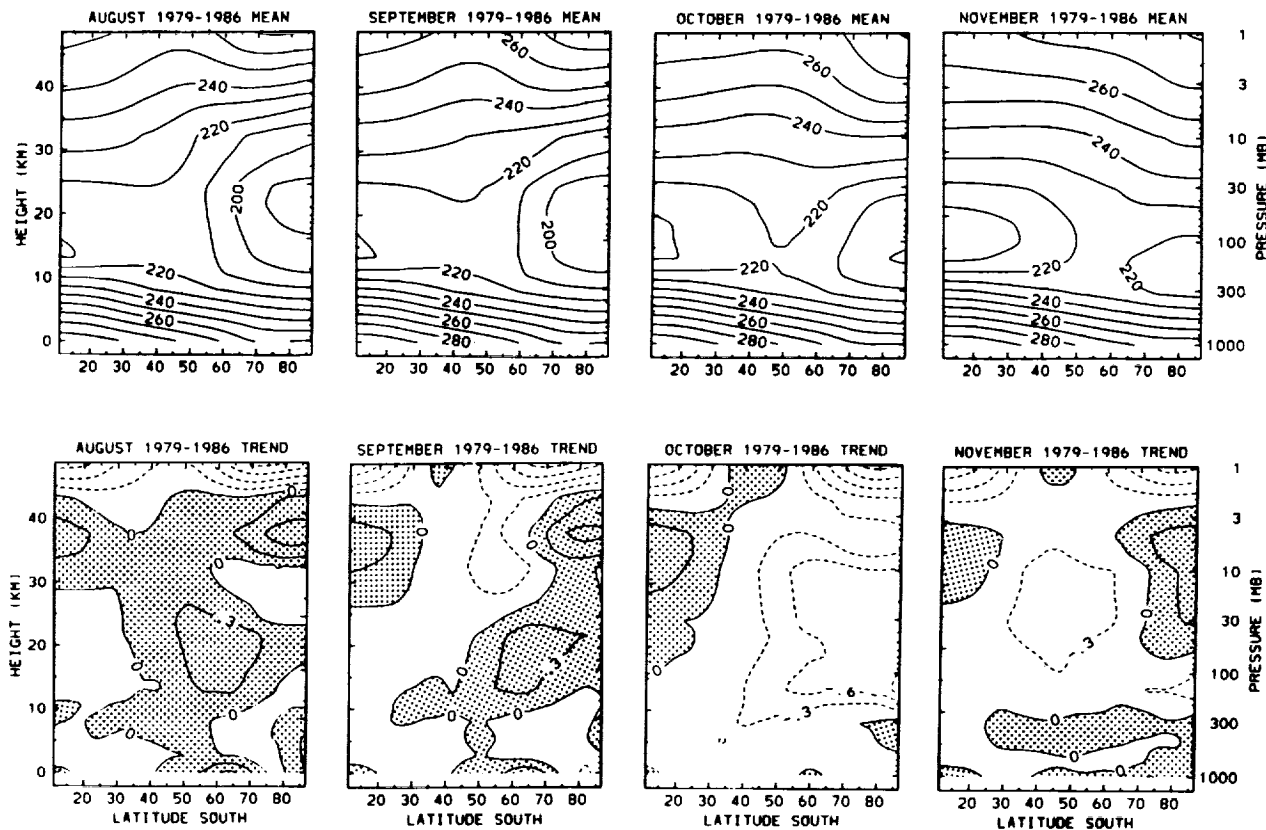

Figure 11.35. NMC 1979–1986 zonal mean temperature averages (top, °K) and 1979–1986 trends (bottom, °K/yr) for August, September, October, and November. Taken from Newman and Randel (1988).

Newman and Schoeberl, 1986; Newman and Randel, 1988; Chubachi, 1986; and Angell, 1986). Temperature and ozone do not decrease monotonically over these years, due to large inter-annual variability (i.e., the relatively warm, active years of 1979 and 1982, and the cold, quiescent years of 1980, 1983, and 1985; see Farrara and Mechoso, 1986; Shiotani and Gille, 1987; and Newman, 1986). Garcia and Solomon (1987) reemphasized an apparent association of polar temperatures and total ozone with the sign of the equatorial lower stratospheric quasi-biennial oscillation (QBO), although the mechanism for this association is not fully understood (see also Hasebe, 1984). Since the QBO was in opposite phases during 1979 and 1985, some part of the trend estimate over the 1979–1985 period can be attributed to the QBO. This component of the estimated trends is believed to be small, however, so that linear trend analysis can be applied to time series over 1979–1985 to objectively identify large temporal changes over these years.

Angell (1986) considered a composite of rawinsonde temperatures from 16 stations distributed over the Antarctic continent. Some of his results are reproduced in Figure 11.38. Two features are readily apparent: the natural level of interannual variability appears to be much greater in the spring (SON) season, and a consistent decline in temperatures during this season appears to have been sustained since 1979. This cooling trend has a temporal signature similar to the recent trend in total ozone. Both total ozone and lower stratospheric temperature have been below normal and declining approximately linearly with time since about 1980. Angell's time series ended in 1985, a year known to be relatively cold; when combined with the method of smoothing the time series, this gives a very strong suggestion of a cooling trend in recent years.

ANTARCTIC OZONE CHANGES

a) OCT. NMC 100 mb TEMP DIFF 79–83

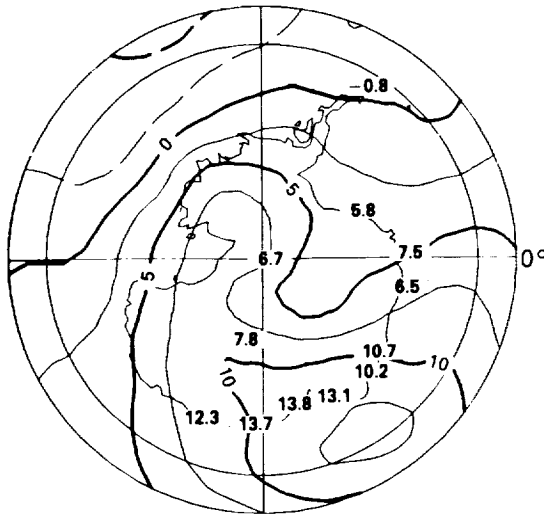

b) OCT. NMC 30 mb TEMP DIFF 79–83

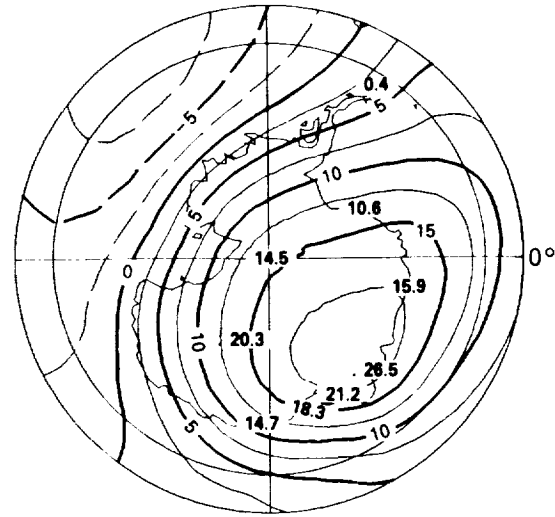

c) OCT. TOMS TOT OZONE DIFF 79–83

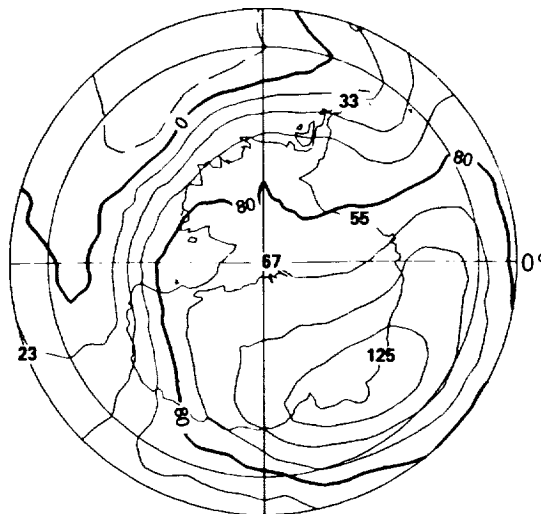

Figure 11.36 NMC temperature differences between 1979–1983 at (a) 100hPa and (b) 30hPa, with RAOB differences superimposed in bold type. The bottom figure shows the TOMS total ozone difference. Taken from Newman and Randel (1988).

Since he used a seasonal rather than a monthly basis in preparing the data, it is impossible to say which months contribute most to the indicated cooling. Evidence presented below suggests that the greatest changes occurred during October and November.

The contrast between the behavior of 100hPa temperatures at Halley Bay, where no trend appears, and Syowa, where for October and November means there does appear to be a trend, is probably related to the large amount of geographic structure in monthly mean temperature changes. Figure 11.31, taken from Newman and Randel (1988), shows time series of October-mean 100hPa temperatures from a selection of stations around Antarctica. It is apparent from this figure that the variations from year to year and from station to station are on the order of

ANTARCTIC OZONE CHANGES

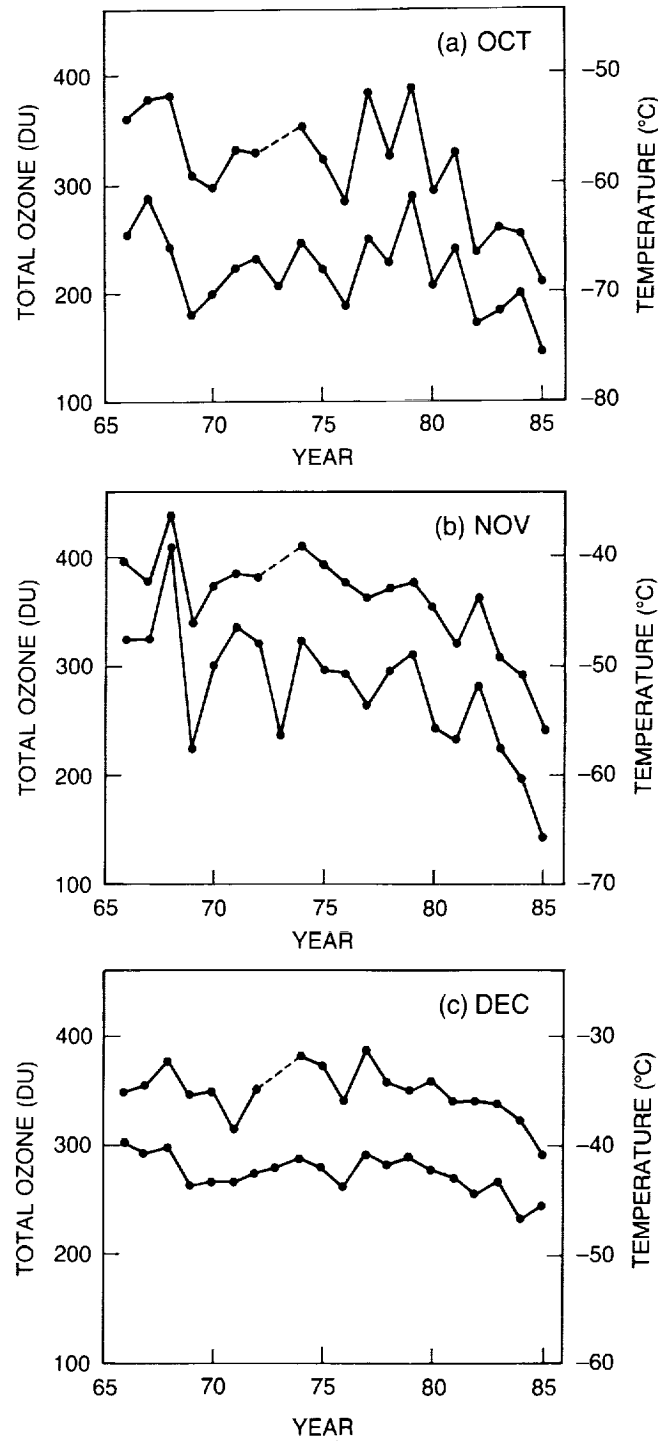

Figure 11.37. Year-to-year change of monthly total ozone amount and 100hPa temperature at Syowa Station: (a) October, (b) November, and (c) December. Taken from Sekiguchi (1986).

10 K—larger than any trend that has occurred during the past 5 to 10 years. These data show that while 1979 was relatively warm, it is not the warmest year in the record. Likewise, while 1985 was cold, several other years were nearly as cold, or colder (such as 1969 and 1973). Stations along the

ANTARCTIC OZONE CHANGES

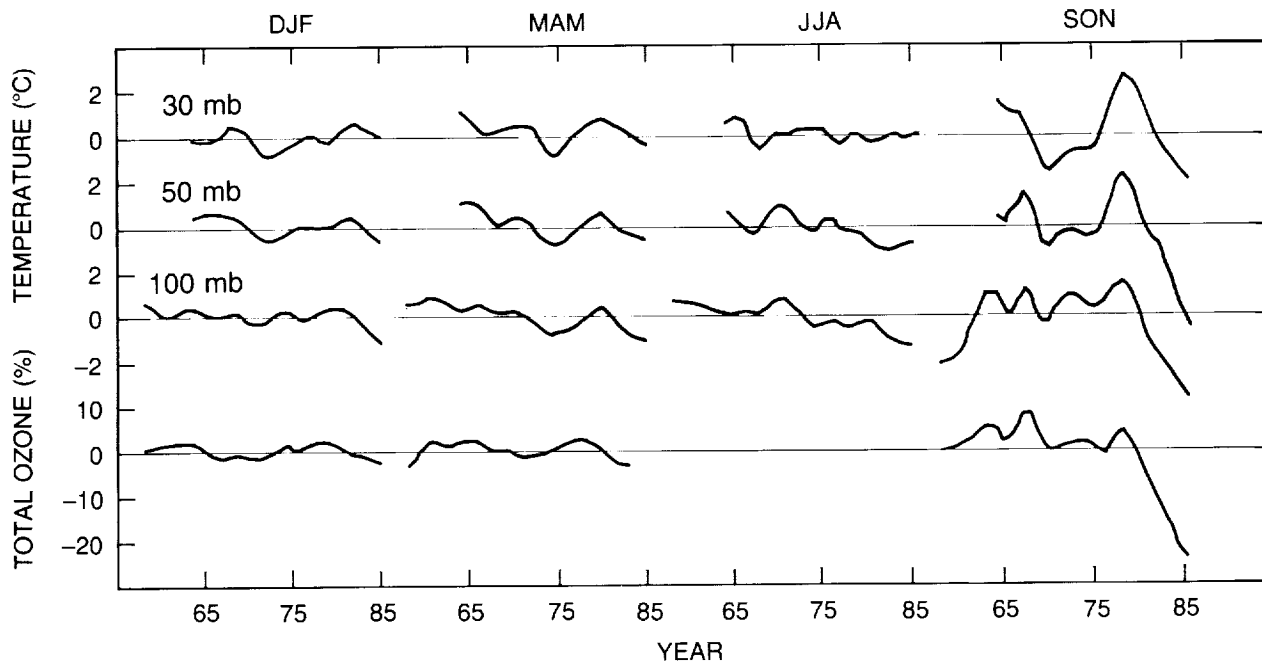

Figure 11.38. Smoothed seasonal (DJF is December–January–February, etc.) temperature deviations at 100, 50, and 30hPa above Antarctica compared with smoothed seasonal total ozone deviations in Antarctica (except for JJA, for which there were insufficient data for analysis). The smoothing involved a 1–2–1 weighting applied twice, except 1–1 at the beginning and end of the record. Taken from Angell (1986).

east Antarctic coast, such as Molodeznaja, Davis, and Casey, show a modest, but consistent, decline between 1979 and 1985, but 1986 was a warm year and breaks the appearance of declining temperatures at these stations. October temperatures at all of the stations shown were significantly higher in 1986 than in 1985. Preliminary data (not shown) indicate that 1987 was again cold. A substantial amount of this year-to-year variability may be associated with the QBO.

Monthly mean temperatures at 100hPa for November are shown in Figure 11.34. The general conclusions are the same as for October. Interannual variability is large, and a succession of years with declining temperatures in east Antarctica was interrupted in 1986 by a relatively warm year at many stations. Although the time series from 1966–1985 at Syowa suggests a long-term downward trend (as discussed in Chubachi, 1986, and Sekiguchi, 1986), data at other stations do not show such a consistent decline. When the temperature variations over 1979–1985 are viewed in longer term perspective, particularly with the inclusion of the warmer 1986 spring, the appearance of a downward trend in recent years is less convincing. October average temperatures for the 30hPa level are shown in Figure 11.32. At this higher level, the amplitude of the year-to-year changes is greater, but the impression of declining temperatures since 1979 is correspondingly stronger and the rise in 1986 is comparatively smaller. Although several stations indicate declining temperatures in recent years, the level of natural interannual variability in station data and the relatively recent onset of the ozone decline make it difficult to determine the existence or magnitude of a secular trend in temperature. The frequent occurrence of cold years recently (1980–1981, 1983–1985) may or may not be associated with a long-term trend.

ANTARCTIC OZONE CHANGES

11.2.3.4 Analyzed Fields

Analyzed maps of temperature based on a combination of rawinsonde and satellite data are available from the NMC. Figure 11.35 (from Newman and Randel, 1988) shows monthly averaged zonal means of temperature and their linear temporal trends (calculated by regression at each point in the latitude–height plane) over 1979–1986, for August through November. The zonal mean temperatures show the substantial seasonal increase in the temperature of the polar lower-to-middle stratosphere between August and November. The morphology and dynamics of the spring warming in the Antarctic stratosphere have been documented by Farrara and Mechoso (1986), Shiotani and Gille (1987), and Mechoso et al. (1988).

A linear temporal trend calculated from a number of years of data is a more robust method for determining decreases with time than a simple difference between any 2 years. The period 1979–1985 has often been used in calculating recent trends because satellite data are readily available for it. Monthly mean temperatures for October show the largest decline over 1979–1985, with large negative trends indicated for much of the lower-to-middle stratosphere poleward of 50°S. November trends show cooling primarily in the polar lower stratosphere near 100hPa. The variation in monthly mean trends in Figure 11.35 suggests that the September–November averages of Angell (1986) give a substantial underestimate of the magnitude of the October temperature change, since no trend is apparent during September. In fact, computations of temperature trends for individual stations by month instead of by season are in excellent agreement with the zonal mean trends shown here (Angell, 1987, private communication).

11.2.3.5 Conclusion

Substantial evidence has been presented for a decline in the temperature of the lower stratosphere over Antarctica since 1979 in October and November. The downward trends appear most strongly in October, when a substantial decline is observed in the middle as well as in the lower stratosphere. During November, the trend is confined to the lower stratosphere, with a maximum negative trend of about 1 K per year, centered at about the 100hPa level. August and September temperatures show little or no trend over 1979–1985. The decline appears in both rawinsonde station data and NMC gridded data that include satellite information.

11.3 TRANSPORT THEORIES FOR THE ANTARCTIC OZONE HOLE

11.3.1 Basic Dynamical Concepts and Ozone Transport

An understanding of the distribution of total ozone requires the integration of chemical, radiative, and dynamical processes. Because the source of ozone in the stratosphere is photodissociation of the oxygen molecule, the largest production of ozone would be expected in the latitude belts with the most intense insolation. If all of the chemical mechanisms for removing ozone from the stratosphere are also included, photochemical processes acting alone would still produce the maximum amount of total ozone in the Tropics. The distribution of the total ozone column with latitude and season bears little resemblance to what would be expected on the basis of the latitudinal and seasonal distribution of the net photochemical source of ozone. Figures 11.39 and 11.40 show the distribution of zonal-mean total ozone with latitude and season as derived from ground-based observations prior to 1974 by Dütsch (1974), and from the TOMS

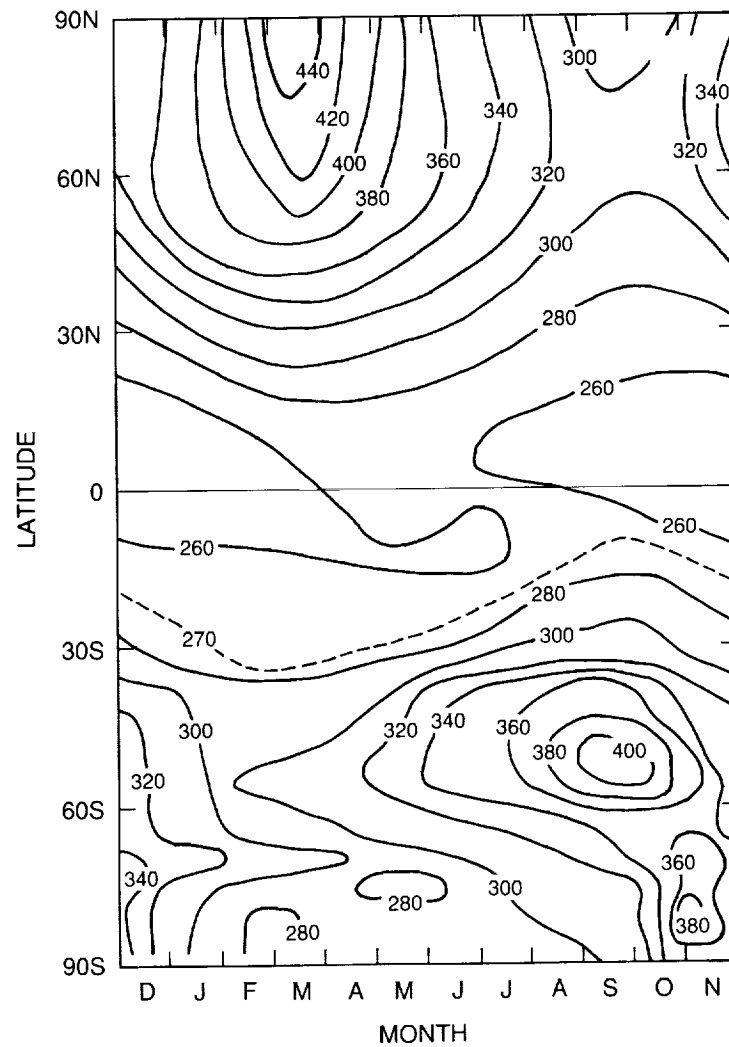

Figure 11.39. Latitude–time contour plots of the annual variation of zonal mean total ozone from Dobson stations before 1974 (from Dütsch, 1974).

instrument on the Nimbus-7 satellite from October 1979 to September 1982 (Bowman and Krueger, 1985). The maximum total ozone occurs not in the Tropics, where the source is greatest, but, rather, in high latitudes. In the polar regions, the maximum occurs not in summer, when the insolation is greatest, but in early spring.

The distribution of total ozone measured by TOMS shown in Figure 11.40 (Bowman and Krueger, 1985) also reveals the dramatic differences between the northern and southern polar regions that have been known since the early 1960's. In the Northern Hemisphere, the maximum ozone column of about 440 DU occurs near the pole around April 1. In the Southern Hemisphere, the maximum of about 400 DU appears off the pole at about 60°S November 1, which is later in the austral spring season than the maximum occurs in the boreal spring. The maximum ozone at the South Pole does not occur until around December 1, and reaches a value of only about 350 DU. Earlier ground-based measurements support the much later and weaker increase of total ozone in the Antarctic than in the Arctic (Dobson, 1966). The dip in total ozone near the South Pole in October shown in Figure 11.40 is the signature of the springtime Antarctic depletion that

ANTARCTIC OZONE CHANGES

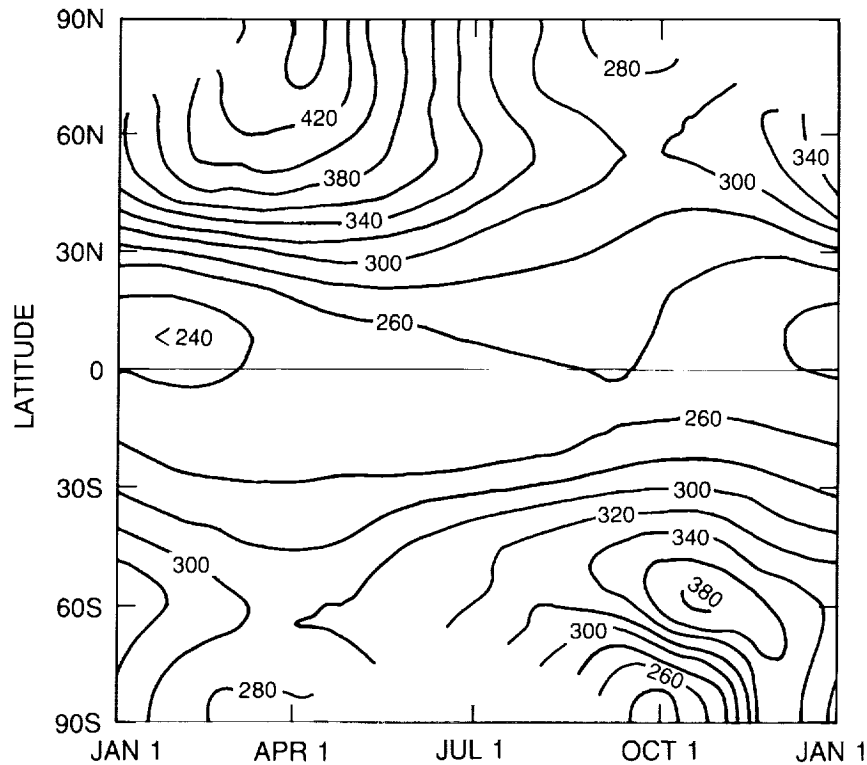

Figure 11.40. TOMS satellite data versus latitude and season between 1979–1982 (from Bowman and Krueger, 1985).

developed sometime after 1975. Earlier data presented by Dobson (1966) for Halley Bay (76°S) and the South Pole show no such depletion, with total ozone values around 280 DU for both September and October (see also Komhyr et al., 1986, and Bojkov, 1986b).

The observation that maximum column ozone amounts are always observed at locations and times that are so strikingly different from those of the maximum photochemical source of odd oxygen was a subject of great interest to pioneers such as Chapman and Dobson. The explanation is well known and well understood, at least in broad outline. It begins with the fact that most of the ozone resides in the lower stratosphere, where photochemical sources and sinks of ozone are normally rather slow, and thus where ozone normally has a long lifetime. The increase during winter of the total ozone column in high latitudes is produced by a downward and poleward transport of ozone from the production region in the middle stratosphere (e.g., Brewer and Wilson, 1968). An early calculation of the meridional circulation in the stratosphere was made by Murgatroyd and Singleton (1958). More recent calculations of the mean meridional circulation in the stratosphere have been made by Dunkerton (1978), Holton and Wehrbein (1980a,b), Gille et al. (1987), and a number of others. Discussions of the processes that maintain these circulations can be found in Chapter 6 of WMO (1986) and Chapter 7 of Andrews et al. (1987).

The intensity of meridional mass circulation in the stratosphere is determined by a complex interaction between radiative and dynamical driving. To simplify consideration of these mechanisms, it is often useful to separate the fields of interest into the average around latitude circles,

the zonal average or mean, and the deviations therefrom—the eddies. This separation is not without pitfalls, however, since the definition of mean, and hence the division into mean and eddies, is inherently arbitrary, and chosen for mathematical and graphical convenience. In general, the zonal mean and the eddies are neither logically nor physically independent. When the flow becomes distorted and nonlinear processes become dominant, the insight that can be provided by separation into zonal mean and eddies becomes severely limited. If the definition of mean is chosen carefully, the mean motion takes the form of the “transport circulation” or, approximately, the “residual” or “diabatic” circulation (Plumb and Mahlman 1987 discuss the relationship between these; see also WMO 1986, Chapter 6). The remaining eddy effects are frequently diffusive and approximately directed along isentropic surfaces. A formulation of the governing fluid dynamical equations that provides the convenience of the zonal mean/eddy decomposition with a minimum amount of potential for confusion is the Transformed Eulerian Mean (TEM) formulation (Andrews and McIntyre, 1976; Boyd, 1976; Edmon et al., 1980). The equations for this formulation and some of its dynamical consequences are given in Chapter 6 of WMO (1986). For the purposes of this discussion, it is useful to review several aspects of the zonal-mean mass overturning, or mean meridional circulation, that are especially apparent when viewed in the TEM context.

The mean meridional circulation is a response to the unequal distribution of solar heating, with latitude and the zonal force provided by wave driving. The climate in the stratosphere can vary widely, depending principally upon the amount of forcing of momentum associated with wave propagation from the troposphere. If the wave forcing is strong, as it is in the Northern Hemisphere during winter, then the temperatures will be relatively far from radiatively determined values. In this case, substantial radiative cooling, downward motion, and downward tracer transport will occur in high latitudes. If the wave forcing is weak, then the temperatures in high latitudes during winter will be colder and closer to radiative values, the radiative heat loss will be less, and the downward motion will be relatively weak. The latter case describes the situation in the lower stratosphere of the Southern Hemisphere where the ozone decline has been observed. The relationship between wave driving from below and the zonal mean state in the stratosphere is complicated by the fact that the upward propagating waves are strongly affected by the mean state. Conditions in the stratosphere are achieved by a complex interaction among radiative heating, wave driving from the troposphere, and dynamical processes within the stratosphere. Clear testimony to the potential for strong interactions between the upward propagating planetary waves and the zonal mean state in the stratosphere is given by the occasional major midwinter warmings observed in the Northern Hemisphere.

The difference in the mean mass circulations in the two hemispheres can partially explain the differences in the total ozone behavior between the polar regions in both hemispheres. The greater wave activity in the Northern Hemisphere, which is rooted in the greater east-west variations in continentality and orography there, leads to a stronger mass overturning and, hence, to a stronger downward transport of ozone in high latitudes. To this effect must be added the lateral mixing associated with the upward-propagating planetary waves when they break in the stratosphere. In the Northern Hemisphere, the polar vortex is often completely broken apart in midwinter by the action of upward propagating planetary waves. When this happens, air parcels in the lower stratosphere experience displacements of great distance in latitude that are, to a varying extent, irreversible, and that may lead to major redistributions of chemical species, including ozone. The remarkable differences between the total ozone distributions with latitude and season in the two hemispheres are closely associated with the fact that planetary waves are more intense and more extensive in the Northern Hemisphere, and that major warmings occur there.

ANTARCTIC OZONE CHANGES

In the Southern Hemisphere, thermal and orographic surface boundary conditions are more nearly zonally symmetric than in the Northern Hemisphere, so that the forcing by planetary waves is weaker (Mechoso et al., 1985). The resultant mean state consists of a nearly zonally symmetric vortex with rapid circulation around a relatively cold pole in the troposphere and lower stratosphere (e.g., Harwood, 1975a; Leovy and Webster, 1976; and Hartmann, 1976a,b, 1985). The contrast between the midwinter temperature distributions in the two hemispheres is shown in Figure 11.41a,b. The cold pool of air in the lower stratosphere over Antarctica is quite evident and very different from the much warmer lower stratosphere over the North Pole.

Because of the greater zonal symmetry of the lower boundary forcing, the polar vortex in the Southern Hemisphere is not only stronger, but maintains its integrity throughout the winter and well into the spring season. The final breakdown of the polar vortex is normally complete by April in the Northern Hemisphere, whereas in the Southern Hemisphere, a well-defined vortex in the lower stratosphere may exist until late November. The lower stratospheric polar vortex thus persists about 2 months longer into the spring season in the Southern Hemisphere. The contrast between the springtime circulations is illustrated in Figure 11.41c,d, which shows the zonal wind distributions for October in the south and for April in the north. A strong circumpolar westerly jet is centered at about 10hPa and 70°S, but in the north, the westerly jet has been obliterated by more intense planetary wave activity. The observed morphology and dynamics of the final spring warming in the Southern Hemisphere have been described by Farrara and Mechoso (1986), Shiotani and Gille (1987), and Mechoso et al. (1988).

Another way of viewing the dynamics of the polar vortex is through maps of potential vorticity on potential temperature surfaces (isentropic potential vorticity IPV maps, e.g.; Hoskins et al., 1985). Under adiabatic and frictionless conditions, both potential temperature and the distribution of Ertel's potential vorticity on isentropic surfaces are conservative quantities. Therefore, parcels remain on isentropic surfaces and maintain their potential vorticity as they move laterally on those surfaces. As a result, parcels of air cannot move laterally across IPV contours. The stratospheric polar jet stream is marked on IPV maps as a region of strong gradient. The jet stream axis is thus associated with a region where lateral mixing between high and low latitudes is inhibited to the extent that the flow is frictionless and adiabatic, and the potential vorticity experiences no irreversible mixing associated with Rossby wave breaking (McIntyre and Palmer, 1983). When the vortex is relatively undisturbed by asymmetric forcing associated with planetary waves, and a strong circumpolar jet stream and associated strong meridional gradient of potential vorticity exist, meridional mixing of chemical species can be expected to be weak. Under these conditions, the chemical composition inside and outside the polar vortex can be quite different. Even under very disturbed conditions, the core of the vortex may maintain its integrity, as suggested by numerical simulations of Jukes and McIntyre (1987). The vortex is eroded by wave breaking on its outer edge, with little exchange of air into the center of the vortex. The lower stratosphere of the Southern Hemisphere is, therefore, a nearly unique environment in which extremely cold temperatures are maintained for several months during winter and into the spring season, and where the lateral mixing between air that is inside and outside the polar vortex is inhibited during these months.

Several observed features of the ozone decline over Antarctica suggest that altered transport may be an important factor. First and foremost among these is that the decline occurs in a well-defined layer in the lower stratosphere between approximately 12 and 22 km (see Section 11.2). The decline is greatest in polar regions, with few observable reductions Equatorward of midlatitudes in the Southern Hemisphere. In this region, photochemical sources and sinks are normally considered to be relatively slow, and ozone concentrations are strongly influenced by

ANTARCTIC OZONE CHANGES

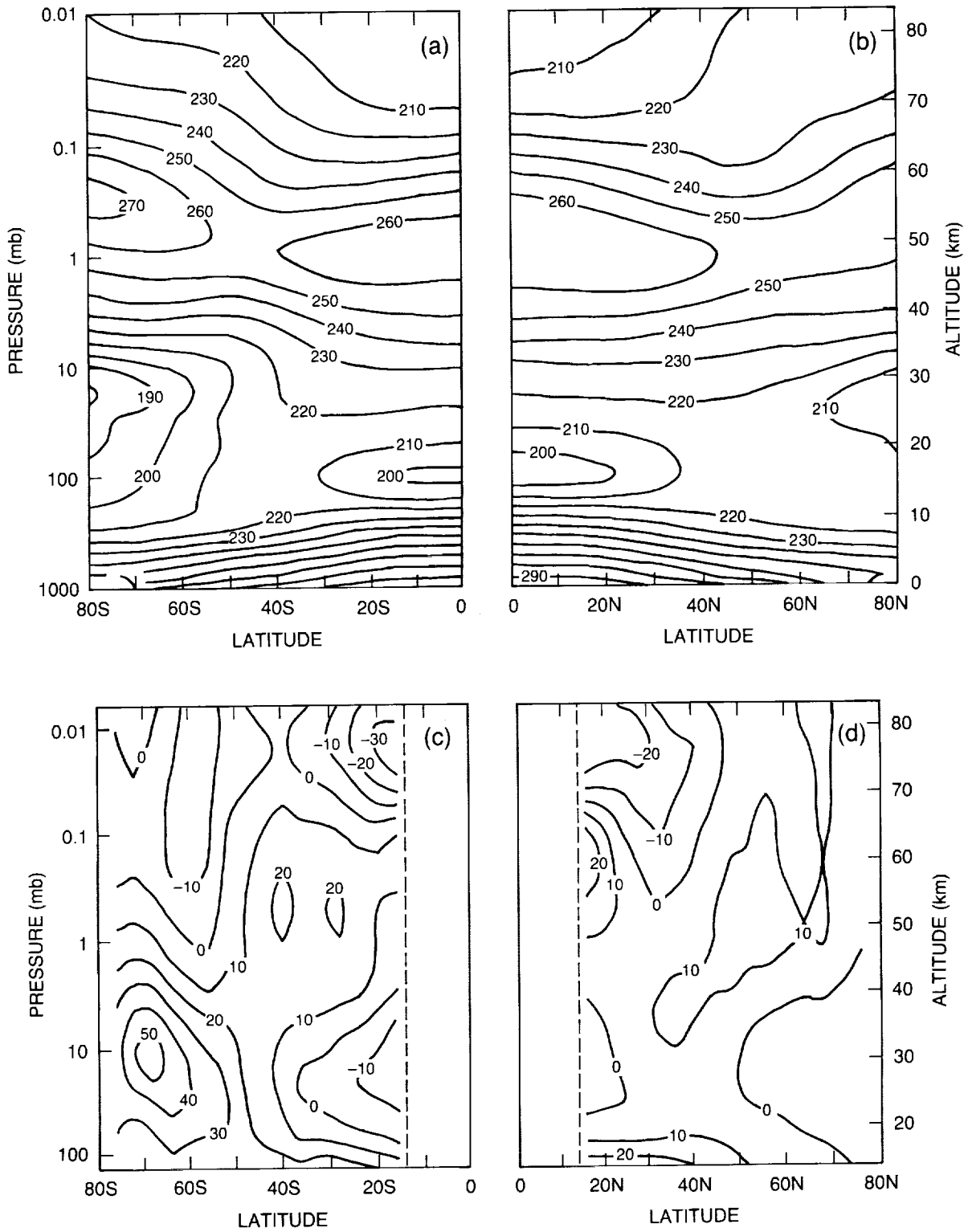

Figure 11.41. Five-year mean climatology of zonal mean temperature (K) for (a) July in the Southern Hemisphere and (b) January in the Northern Hemisphere, and of zonal mean wind (m/s) for (c) October in the Southern Hemisphere and (d) April in the Northern Hemisphere. Taken from Andrews (1989), who adapted the data from Barnett and Corney (1985).

ANTARCTIC OZONE CHANGES

air motions that move ozone downward and poleward. In polar latitudes, ozone concentrations are generally well above photochemical equilibrium values, as already mentioned (e.g., Dobson, 1930; Jackman et al., 1986). This ozone excess is maintained by transport. Because of their relatively small area and dependence on heat imported from other latitudes, the polar regions experience rather large interannual variability and might be expected to respond sensitively to small changes in climate.

Another important feature of the Antarctic ozone decline is that it is concentrated in the spring season. In recent years, the total ozone over Antarctica has departed rapidly from the climatological annual variation during September, yielding the maximum decrease of a monthly mean from previous decades during October. The monthly mean total ozone then returns to near normal by December. A decline during springtime could be associated with a change in the climate and transport in the lower stratosphere above Antarctica, since spring is the time when the polar vortex in the lower stratosphere is changing rapidly.

A key feature of the ozone distribution in recent years—one not previously observed—is that the total ozone declines in an absolute sense between September and October (Figure 11.40). This requires not merely a reduction in the downward and poleward transport of ozone during the spring season, but that this transport actually fall below the rate at which ozone is being photochemically destroyed in the lower stratosphere. If it is assumed that ozone is conservative in the layer of interest, then, to explain the observed decline, transport must actually remove ozone from the lower stratosphere. Within the context of the zonal mean/eddy decomposition used in the TEM formulation, for example, the removal of ozone must be accomplished either by the mean meridional motions or by mixing by eddies. Published transport theories for the ozone decline have focused on the transport associated with the mean diabatic circulation. Because of the rapid increase with altitude of ozone concentration in the lower stratosphere, the observed total ozone decline over Antarctica can be produced with an upward displacement of about 5 km during September. The alteration in the profile of the ozone-mixing ratio that would result from this uplift is similar to that observed.

11.3.2 Transport Theories for the Ozone Hole

In the previous section, the role of transport in determining the distribution of total ozone was reviewed. Because the depletion is confined to the lower stratosphere, where the gradients of ozone mixing ratio are substantial and transport is known to be important, it is reasonable to hypothesize that transport by atmospheric motions might play an important role in the recent decline of ozone over Antarctica. Because of the importance of arriving at the correct scientific understanding of the observed phenomena, it is essential to evaluate carefully the possibility that the ozone hole has resulted wholly, or in part, from an alteration in the transport of ozone from other latitudes, rather than from enhanced photochemical loss mechanisms. The transport theories for the ozone hole and the evidence for and against them will be reviewed in this section.

The central tenet of the transport theories for the Antarctic ozone depletion is that it is a consequence of reduced transport from lower latitudes. Since ozone exists in high latitudes in the abundance that it does, simply because of transport from its source regions by the atmospheric circulation, any interannual modulation of that circulation would be apparent in the column ozone at high latitudes. While on short time scales transport merely effects a redistribution of ozone, it may, over longer periods, affect the total atmospheric loading by determining how much ozone is removed from the middle stratosphere—where its chemical lifetime

is short—and deposited into the lower stratosphere—where much of the total column amount of ozone is located.

To date, most dynamical studies have focused on the possible effects of trends in transport by the mean circulation. Therefore, most of the following discussion will concentrate on this aspect of the problem. Ozone depletion theories that include eddy mixing as well as mean circulations should probably be looked at more carefully in the future. At first sight, it might appear that any quasi-isentropic eddy mixing in high latitudes must increase the column in polar regions where total ozone has a spatial minimum. The isentropes slope steeply upward toward the pole, or, more precisely, toward the temperature minimum, and cross contours of ozone-mixing ratio. Quasi-isentropic transport into the polar region would bring air upward from the lower stratosphere, where ozone is less abundant, and could, therefore, cause a reduction of the high-latitude ozone column. Quasi-isentropic mixing by eddies requires much smaller associated temperature changes than does simple mean ascent.

While a dynamical explanation of the year-to-year decline of Antarctic ozone requires only that the gross effects of transport similarly decline, observations of the springtime seasonal decline place more severe demands on such theories. During this time, the mean motion in the lower stratosphere of high southern latitudes must be upward to bring ozone-poor lower stratospheric air into the high-latitude column. If consideration is limited to mean motions, upward motion appears to be the only alternative to a chemical sink as an explanation of the seasonal depletion. It is not required that the motion be upward everywhere in the polar region, but it is, of course, necessary that it be so where the depletion is occurring.

The mean circulation is driven by eddy transport processes and radiative heating (see *WMO*, 1986, Chapter 6). During transient episodes, such as following polar sunrise in September, both radiative heating and eddy transport are highly transient and could contribute to upward motion that would support the severe ozone decline observed then. Therefore, an interannual trend in high-latitude mean vertical motion could arise from either increased radiative heating or reduced eddy transport. Increased radiative heating might be associated with a trend in aerosol concentration, for example. Reduced eddy transport could be caused by changes in the wave generation processes in the troposphere or altered wave transmission properties of the stratosphere, and would be indicative of a more widespread climate drift in the Southern Hemisphere. In the case of reduced eddy transport of heat, reduced polar ozone should be accompanied by reduced polar temperatures. Evidence of such cooling during October and November and of other aspects of a climate drift, both in the stratosphere and troposphere, is noted in Section 11.3.3, although it is also demonstrated that the cooling of the lower stratosphere could be a radiative response to the ozone decline.

Published theories for the Antarctic ozone decline that invoke altered transport as a primary cause of the reduction during September and October all share certain basic assumptions. They assume that ozone in the lower stratosphere can be considered a conservative quantity on monthly time scales. This assumption requires not merely that there be a reduction of transport into the lower stratosphere, but that ozone actually be exported from the south polar region during September. The method that these theories use to remove ozone from the polar region is transient mean upward motion during the spring season.

Tung et al. (1986) noted that the lower stratosphere over Antarctica is exceedingly cold during the spring season, so that the radiative cooling is probably small when the Sun returns to Antarctica in September. Under these conditions, anomalous upward motion could be induced

ANTARCTIC OZONE CHANGES

by a fairly small change in the climate. One mechanism that they proposed for producing this anomalous rising was heating associated with increased aerosol loading of the lower stratosphere. Tung and Yang (1988,1989) used a two-dimensional model to simulate the seasonal and latitudinal distribution of ozone. By using observed temperatures and determining the radiative heating by relaxing to calculated radiative equilibrium temperatures, they were able to obtain a reasonable simulation of conditions prior to 1979. Adding an arbitrary additional heating beginning in 1983 to simulate an assumed heating associated with El Chichón aerosols, they produced a springtime ozone minimum in fair agreement with that shown in Figure 11.40. Tung and Yang (1988,1989) needed an aerosol heating that reached a maximum of 0.5 K per day toward the end of October to produce the decline in total ozone.

Mahlman and Fels (1986) begin with the assumption that a reduction in wintertime planetary wave activity occurred some time after 1979. As outlined above, a reduction in planetary wave activity would result in reduced ozone transport into the polar lower stratosphere via reduced mean mass circulation and reduced eddy mixing. Reduced eddy activity in the stratosphere would also mean that the polar vortex would persist longer into the spring season. Reduced planetary wave activity during winter would produce lower total ozone during the spring season, but cannot by itself explain the observation that a good portion of the ozone decline occurs as an absolute decrease during September. To explain this transient decline, Mahlman and Fels (1986) invoked radiative heating as the Sun returns to Antarctica during spring. If the temperatures in the lower stratosphere are colder than normal in spring, then more polar warming is required to reach temperatures that are in equilibrium with the increasing insolation. Because momentum, as well as heat, must be readjusted to maintain geostrophic balance, part of the solar heating must be used to support vertical motion, while the remainder supports warming. In the absence of anomalous wave forcing, mean Equatorward motion is required to support deceleration of the westerly winds that must occur in association with the decrease of the meridional temperature gradient as the pole is heated. Continuity of mass requires rising motion over the pole to balance Equatorward flow at lower latitudes. Mahlman and Fels (1986) refer to this chain of events as the "flywheel effect."

Rosenfield et al. (1988) calculated total ozone changes following temperature minima in the NMC daily maps. They used observed temperatures and initial ozone profiles to calculate the change in the ozone profiles produced by vertical motions. The vertical motions were determined from the requirement that they balance the thermodynamic effect of the net radiative heating, given the observed temperature changes. Using this scheme, they found that the ozone column decreased during September at about the observed rate, with no need for aerosol heating. They pointed out that this result was very sensitive to the details of the radiative calculation.

Dunkerton (1988) proposed a somewhat different mechanism, which relies on the wave driving provided by tropospheric eddies. Tropospheric synoptic-scale eddies provide a strong deceleration of the mean westerly winds at about 10 km, as opposed to the planetary waves that propagate to much greater altitudes before producing the majority of their effects on the mean flow (e.g., Hartmann et al.; 1984, Mechoso et al., 1985). This intense deceleration requires a poleward mean meridional flow to balance the momentum loss. Dunkerton argued that this wave driving near 10 km induces downward mean flow below 10 km and upward flow above. The upward flow above 10 km is in the correct position to produce the observed ozone decline in the lower stratosphere. He hypothesized that if the planetary wave driving at higher altitudes were reduced, thus decreasing the diabatic sinking in the spring season, then the upward motion induced in the lower stratosphere by the synoptic-scale eddies might be sufficient to produce net upward motion there.

11.3.3 Evidence For and Against Transport Theories for the Ozone Hole

11.3.3.1 Evidence for a Climate Drift in the Southern Stratosphere

If a significant change in the circulation of the Southern Hemisphere stratosphere has occurred during the last 10 years, then this should be reflected in other variables besides total ozone. In particular, it may be expected that if a subtle climate drift were taking place, it would be rooted in some surface condition with a relatively long time scale, such as sea surface temperature or sea ice. In this section, the evidence for changes within the stratosphere is evaluated, and some evidence for tropospheric climate changes is discussed.

Temperature Trends

The participation of dynamical processes in ozone depletion is suggested by the observation of a downward trend in October mean stratospheric temperature at high southern latitudes. As discussed in Section 11.2.3, NMC analyses (Newman and Schoeberl, 1986; Schoeberl et al., 1986) show a negative trend in the Antarctic lower stratosphere of almost 1 K per year around 100hPa and about twice that between 30 and 10hPa (Figure 11.36). Little or no such trend is evident in the September monthly mean temperature. For November, only the trend centered near 100hPa is observed. The existence and structure of temperature trends over Antarctica for the months of September, October, and November of the past 10 years provide crucial clues to the processes contributing to ozone depletion. The structure, relative amplitude, and timing of the ozone and temperature changes provide information on the extent to which ozone depletion causes the temperature decline, or to which both have a common cause, such as an anomalous vertical displacement.

Evidence that the cooling is a radiative response to the ozone decline will be presented below. If we assume for the sake of argument that the cooling is not a radiative response to the ozone depletion, then the most obvious interpretation of the data is that both cooling and depletion are a response to a trend in vertical motion. Interpreted as an indicator of a mean circulation shift, the cooling trend in the Antarctic lower stratosphere implies a secular reduction or even reversal of the climatological mean subsidence there. On a day-to-day basis (and also spatially), a correlation between ozone and temperature is a familiar feature of the observational record and is usually taken to indicate the effects of adiabatic vertical motion on the two. Over short time scales, both ozone and potential temperature usually can be regarded as conservative, so that both respond to vertical motion in the same way, since both are strongly stratified in the vertical and, in the lower stratosphere, increase upward. That such effects can occur on an interannual basis in the south polar regions in spring is illustrated by the quasi-biennial oscillation in ozone and temperature there (Garcia and Solomon, 1987). Tung and Yang (1988, 1989) have estimated that upwelling that adiabatically induces a 2 K decrease in lower stratospheric temperature will cause a 3.5 percent depletion of ozone. Allowing for diabatic effects, they estimate a 7 percent ozone response for the same temperature change (i.e., the same temperature change would require twice the vertical displacement as in the adiabatic case). This is roughly consistent with the observed trends in total ozone and lower stratospheric temperature, though the relationship is sensitive to the assumed vertical gradient of the ozone-mixing ratio.

Even with the long radiative time scales of the lower stratosphere, significant memory in the thermal field is unlikely. The ozone in the Southern Hemisphere lower stratosphere, however, may be sufficiently long-lived for some portion of the springtime depletion to survive through the following year. This might be possible because of ozone's long chemical lifetime there and

ANTARCTIC OZONE CHANGES

because, dynamically, the Southern Hemisphere lower stratosphere is relatively isolated from the rest of the atmosphere except in late spring. This possibility was suggested by Mahlman and Fels (1986), who noted that, in simple ozone experiments with the GFDL general circulation/tracer model (Mahlman et al., 1980), October total ozone at 84°S took several years to reach equilibrium with a constant source. There is some evidence of such memory in the observational record. TOMS total ozone data integrated over the area south of 44°S presented in Figure 11.15 suggest that a small part of the springtime ozone depletion may persist through the year. In particular, the very low values at the end of 1985 persist well into 1986 before recovering in May and June, at the beginning of the 1986 winter.

Labitzke (1987) has drawn attention to a sudden and apparently significant change that occurred around 1979 in the October mean geopotential height of the 50 mb surface at the South Pole. In fact, the year-to-year ozone depletion appeared to correlate better with the station geopotential data than with temperature. What this means, on the basis of data from a single station, is difficult to ascertain. The geopotential trend could indicate a change in the position or in the intensity of the circumpolar vortex. There is, in fact, some evidence for both of these possibilities. The synoptic structure of trends in stratospheric temperature or, for that matter, ozone (Figure 11.42), shows changes that are related to shifts in the location of both the polar vortex and the midlatitude anticyclone over the years since 1979. There also appears to have been a trend in the vortex intensity. Austin et al. (private communication, 1988) found a substantial increase in the area enclosed by a given potential vorticity contour on the 1,200 K isentropic surface (about 2hPa), but not at 850 K (about 10hPa), during 1979–1986.

Such changes in the transient, springtime stratospheric circulation could result from changes in the radiative drive (through changes in stratospheric aerosol loading, including PSC's) or in dynamical driving by eddy motions. There are some suggestions that there has indeed been a downward trend in the eddy driving. Nagatani and Miller (1987) argued that the Eliassen–Palm (EP) flux upward through the 100hPa surface of the Southern Hemisphere in September has declined since 1979. Figure 11.43, from Newman and Randel (1988), shows the structure of the northward eddy heat flux and its trend over the period 1979–1985. The poleward eddy heat flux

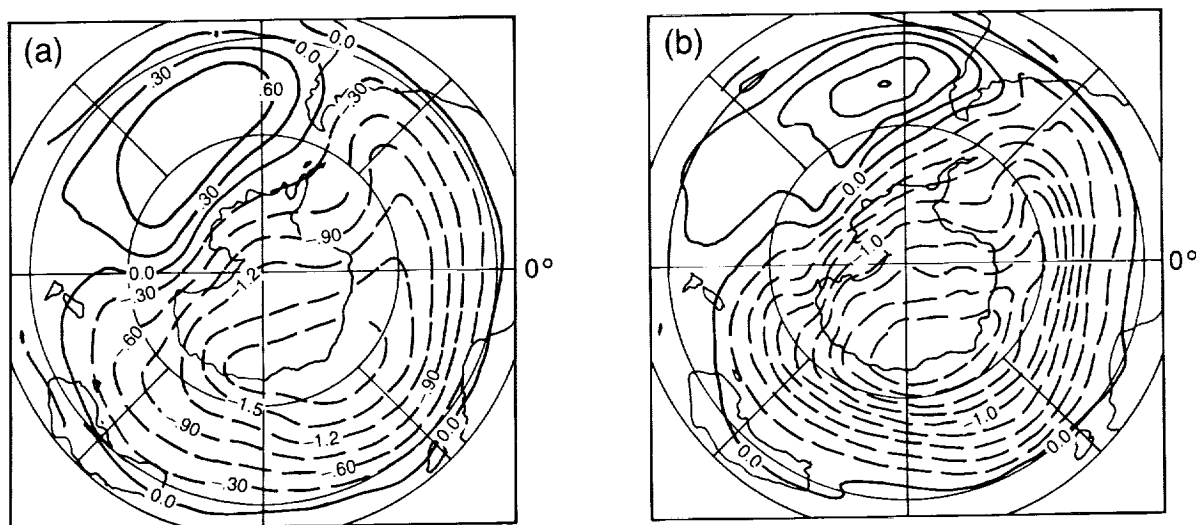

Figure 11.42. (a) October NMC 70 mb temperature trend from 1979 to 1985 and (b) TOMS total ozone trend over the same period. Taken from Newman and Randel (1988).

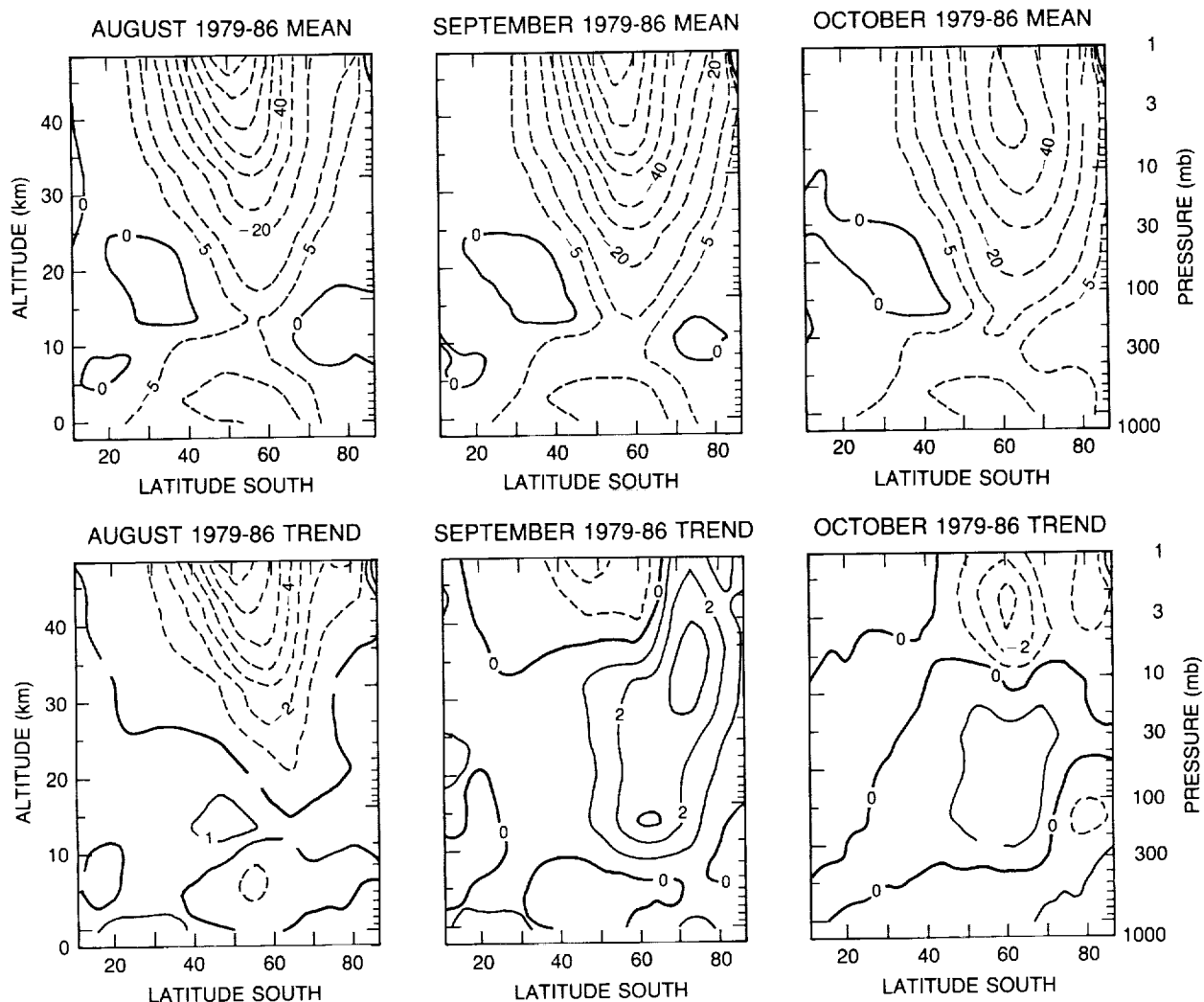

Figure 11.43. Northward eddy heat flux calculated from NMC analyses and averaged over 1979–1985 (top, $^{\circ}\text{K m s}^{-1}$) and the trend in eddy heat flux (bottom, $^{\circ}\text{K m s}^{-1} \text{ yr}^{-1}$) over the same period for August, September, and October. Taken from Newman and Randel (1988).

is proportional to the vertical component of the EP flux, the measure of upward wave propagation. The flux averaged over September has declined everywhere, most markedly in the high-latitude lower stratosphere. Such a decline in the EP flux is qualitatively consistent with the notion that the dynamical driving of the meridional circulation has declined in recent years. October shows a similar, but smaller, decreasing trend. In view of the limited length of the available time series, however, such results should be treated with caution.

Evidence for a Tropospheric Climate Drift

A decline in the upward propagation of wave activity into the stratosphere must be indicative of some change within the troposphere, either in wave generation processes or in transmission characteristics. While direct evidence of such changes has yet to be provided, several examples of trends in key indices of the Southern Hemisphere tropospheric circulation are noteworthy.

ANTARCTIC OZONE CHANGES

Some recent studies have drawn attention to apparent tropospheric and surface temperature trends, especially at high latitudes. Folland et al. (1984) noted an increase in sea surface temperature (SST) over the southern oceans. Austin et al. (private communication, 1988) noted that this increase in winter sea surface temperatures correlates with the decrease in ozone. They also suggested that an increase in the area of the Antarctic sea ice has occurred in recent years. Further, they found evidence for an Equatorward shift of the winter westerlies throughout the troposphere. On the basis of radiosonde data, Danielsen and Houben (unpublished manuscript) found a similar drift of the westerlies in September throughout the depth of the troposphere and lower stratosphere. Unfortunately, it is not clear what significance such trends have for the generation of large-scale planetary waves, since the processes responsible for their generation in the Southern Hemisphere are far from being fully understood.

Unclassified Issues: Causal Mechanisms

An interannual trend in vertical velocity in the springtime southern stratosphere may provide an explanation for the ozone decline; however, the ultimate cause of this climate change has yet to be clarified. Current quantitative dynamical theories (those of Tung and Yang, 1988, 1989; Rosenfield et al., 1988) deduce the mean vertical velocity diagnostically from observed temperatures without attempting to probe the underlying processes driving the circulation. It was noted earlier that the circulation arises from the effects of both radiative and mechanical driving and that interannual trends in the circulation must, therefore, result from trends in one or both of these.

Tung et al. (1986) proposed that increased volcanic aerosols would lead to increased springtime heating in the lower stratosphere. However, these aerosols have, in fact, been decreasing in recent years (McCormick and Trepte, 1986) without any sign of Antarctic ozone returning to normal. Therefore, it seems unlikely that volcanic aerosols can be the cause of the continuing decline of ozone in 1987, though they may have played a role in the early stages of the decline.

On the other hand, Mahlman and Fels (1986) suggested that the circulation change is a response to a decreased dynamical drive, not only allowing the flywheel effect to operate (whereby the transient radiative heating in springtime may drive an upward motion in the polar cap), but also, more generally, resulting in less poleward transport and, therefore, less ozone. The strength of this flywheel effect and its ability to operate on interannual time scales to produce a long-term trend have not been established. Moreover, the temperature trends observed occur for October and November, after the greatest ozone tendency anomaly during September.

Dunkerton (1988) has shown that a transient EP flux convergence in the upper troposphere will drive upward motion in the high-latitude lower stratosphere. Observations suggest, however, that the driving by the tropospheric wave field is relatively steady at this time of year and that the response to steady upper tropospheric driving would be confined to the lower levels. As yet, few theoretical studies of the wave-driven meridional circulation of the springtime southern stratosphere have been made.

Radiative Response to the Ozone Decline

According to the calculations of Shine (1986), some, if not all, of the temperature trend could be a radiative response to the ozone depletion. He found a maximum cooling of 6 K at about 50hPa in response to a 25 percent decrease of column ozone applied to a profile from Syowa between the 250 and 31hPa levels. Calculations similar to Shine's have been completed by

several groups for use in this document. Radiatively determined Antarctic temperatures were computed both with and without an ozone depletion. These calculations used the radiative transfer models shown in Table 6.11, Chapter 6. Spring 1986 ozone measured at McMurdo station was used from the surface up to 30 mb (Hofmann et al., 1989). Above 30 mb, ozone climatology given by McPeters et al. (1984) was used. Figure 11.44 shows time–height contours of the ozone-mixing ratios in ppmv.

The calculations began on September 1. The initial temperature profile, from September 1, 1986, NMC data, was located inside the vortex at the 70 mb temperature minimum. The temperatures throughout the next 2 months were determined by time integration, using only radiative heat transfer. In the depleted ozone runs, the ozone-mixing ratios used were those shown in Figure 11.44, while for the undepleted ozone runs, the ozone-mixing ratios were fixed at the September 1 values. The total ozone on September 1 at McMurdo was 218 DU. A Syowa 1982 Antarctic balloon water profile (Iwasaka et al., 1985b) was used from the surface to 116 mb. Above 116 mb, the water vapor was set at 3 ppmv; no clouds were included. In Models 1 and 3, the solar pathlength computations were modified to include Earth's spherical geometry.

Time–height contours of the computed differences in the radiatively determined temperatures for a latitude of 80°S are shown in Figures 11.45, 11.46, and 11.47, for Models 1, 2, and 3, respectively. The models agree with a maximum cooling of -1.5 K by the end of September, and a mean cooling for the month of September of much less than -1 K. The models also agree in predicting a maximum cooling of -6 K to -6.5 K by October 30. In Models 2 and 3, this minimum

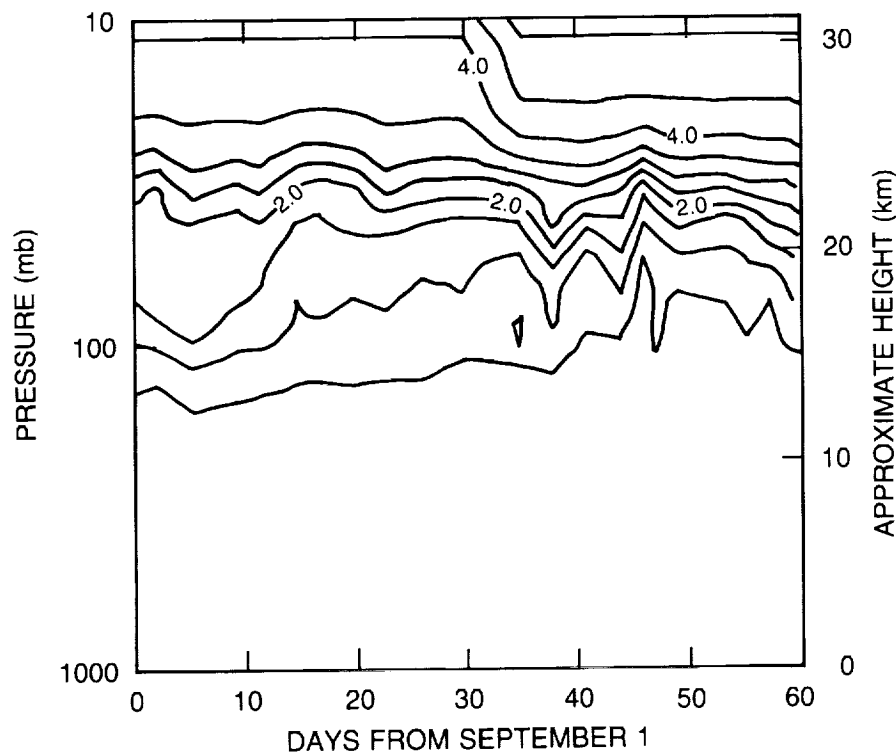

Figure 11.44. Time–height contours of the ozone-mixing ratios used in the radiative heating calculations with depleted ozone. Contours are 0.5 ppmv.

ANTARCTIC OZONE CHANGES

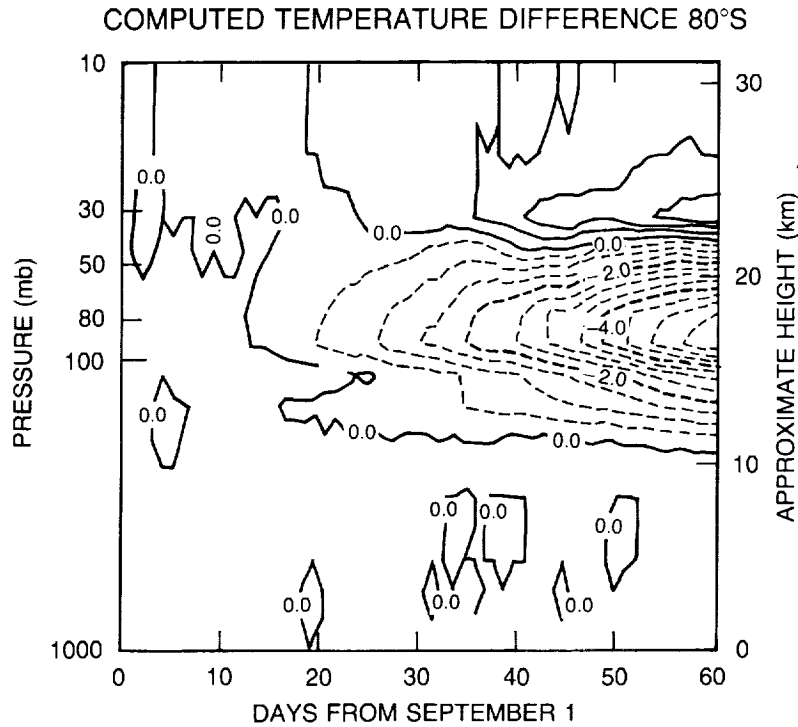

Figure 11.45. Difference of radiatively determined temperatures for depleted and undepleted ozone computed from Model 1, from September 1 through September 30. Units are 0.5 °K.

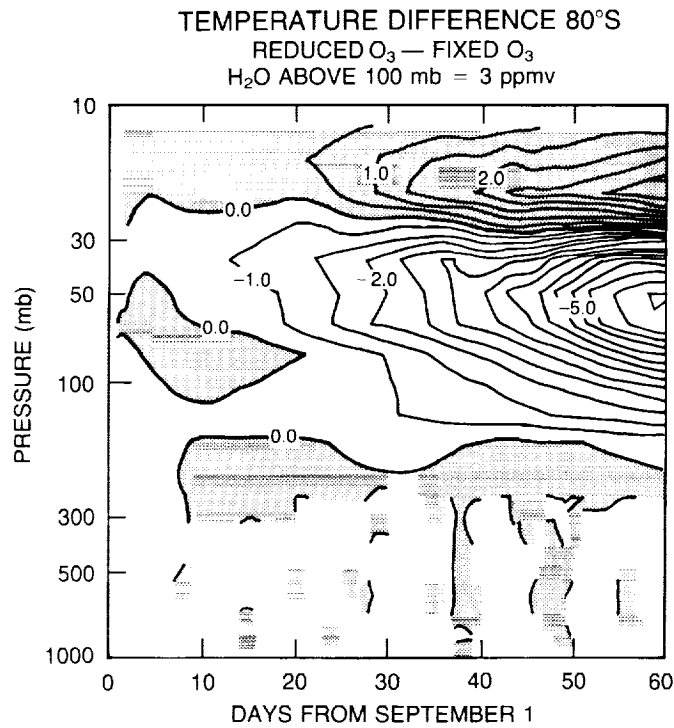

Figure 11.46. Difference of radiatively determined temperatures for depleted and undepleted ozone computed from Model 2, from September 1 through September 30. Units are 0.5 °K.

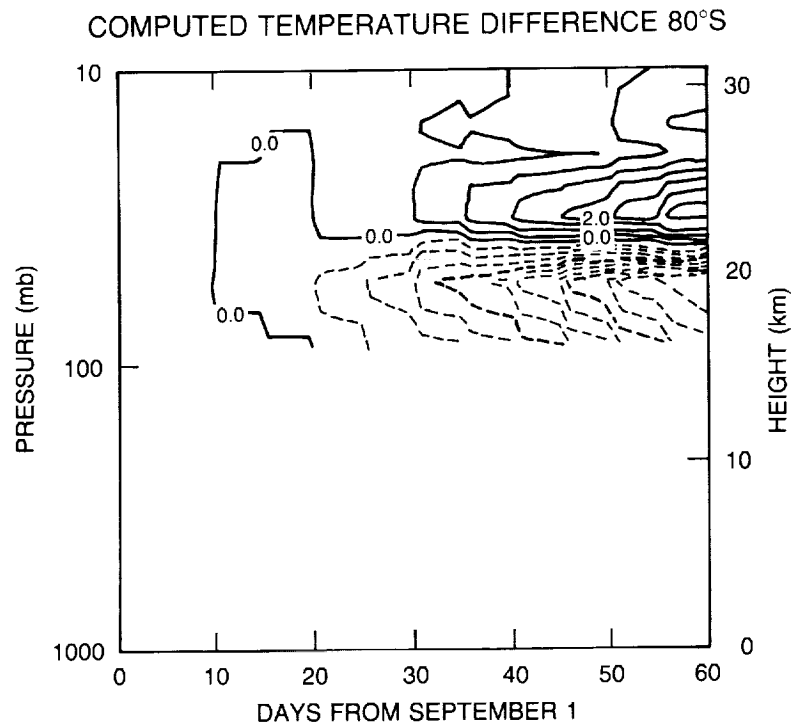

Figure 11.47. Difference of radiatively determined temperatures for depleted and undepleted ozone computed from Model 3, from September 1 through September 30. Units are 0.5 °K.

is found at about 50 mb, while in Model 1, the maximum cooling is at 85 mb. The October monthly mean temperature at the altitude of maximum cooling is predicted to be approximately 4 K colder for the depleted ozone case, relative to the undepleted case. The results of these calculations are similar to those of Shine (1986).

All these calculations predict a warming above the ozone hole that has not been detected in observations. This exceeds 3 K by the end of October in Models 2 and 3. The physical cause of this warming is mainly an increase in the flux of infrared radiation at $9.6 \mu\text{m}$ that penetrates to midstratospheric levels during periods of depleted ozone in the lower stratosphere. A small contribution is from an increase in the penetrations of reflected radiation from the troposphere (see Shine, 1986).

Further computations were made to test the sensitivity of these conclusions to latitude, water vapor profile, cloud presence, and initial ozone-mixing ratio profile. The maximum cooling on October 30 was about 0.5 K less at 70°S and about 0.5 K greater at 90°S, compared to the runs at 80°S. The use of 1.5 ppmv water vapor above 100 mb (instead of 3.0 ppmv) reduced the October monthly mean cooling by about -1 K in Model 2, while it made very little change in the results of Model 1. The presence of black clouds in the infrared, with a cloud top at 250 mb and a cloud fraction of 1 in Model 1, resulted in a reduction in cooling of about -0.5 K. When the computations were initialized with the ozone rich profile of August 30 (total ozone 270 DU) rather than September 1, Model 3 showed a 60 percent greater cooling. Thus, the predicted cooling appears to be most sensitive to the choice of the initial ozone-mixing ratio profile. Calculations with Model 3 showed that 80 percent of the cooling resulted from decreased absorption of solar radiation, and the rest from decreased absorption of upwelling infrared radiation.

ANTARCTIC OZONE CHANGES

Figure 11.48 shows the differences in two series of temperature profiles—the 1985–1986 mean and the 1979–1980 mean NMC temperatures—collocated with the minimum total ozone, which has a variable latitude and longitude. These data show an October mean difference in excess of 4 K near 100 mb, and roughly agree with the model calculations. The greater day-to-day fluctuation of the observed change is associated with dynamical variability. From these studies, it appears that the year-to-year decrease in Antarctic temperature may result primarily from the ozone reduction. Kiehl et al. (1988) pointed out that the radiative effect of an ozone decline in the lower stratosphere feeds back negatively on the vertical motion. If upward motion produces an ozone decline, the reduced solar heating will tend to suppress the vertical motion or induce sinking.

The importance of the change in radiative heating associated with the ozone decline also provides a possible positive feedback on longer time scales. Once the ozone is reduced in the lower stratosphere, the final spring warming will be delayed because of the reduced radiative heating, assuming that the wave driving is unchanged and relatively weak. The polar vortex, with its cold polar temperatures and capacity for isolating the polar region from mixing, will then persist longer into the spring season. The “filling in” of the ozone hole at the time of the final breakdown of the vortex will thus be delayed, possibly allowing the total ozone to reach lower values than it would have done without the radiative/dynamical feedback from the initial ozone decline. In addition, the warming could be more “radiative,” and thereby associated with less lateral mixing. The feedback would be enhanced if the filling in were not complete and memory

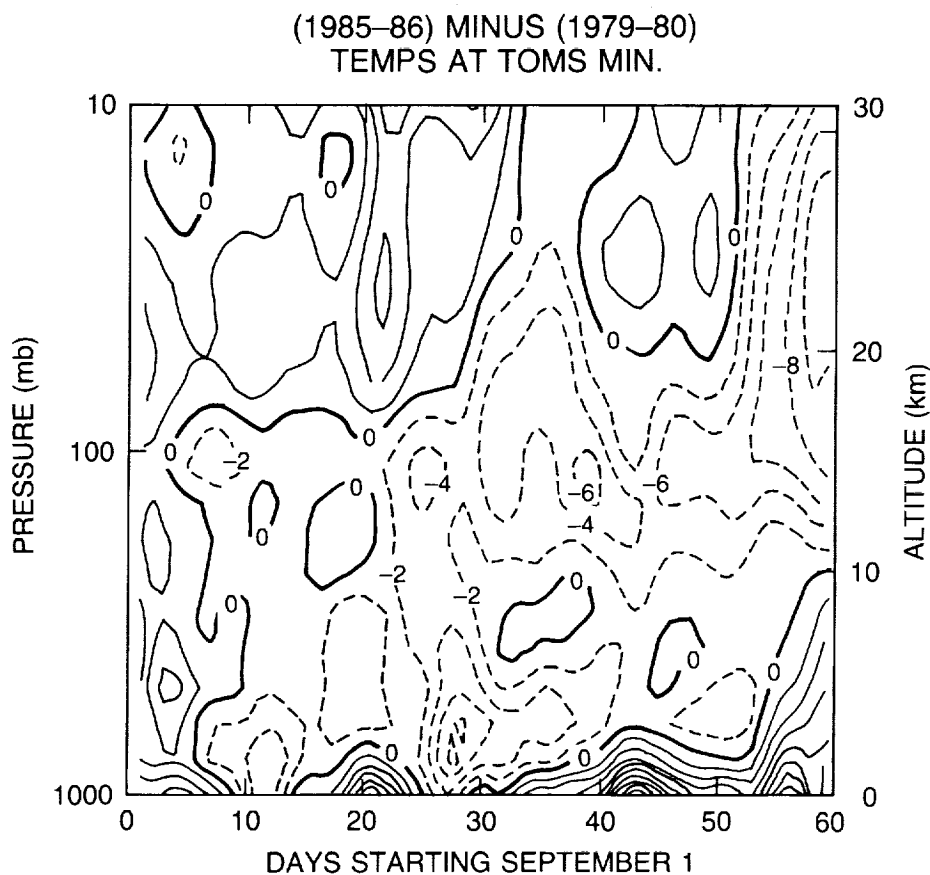

Figure 11.48. The mean of 1985 and 1986 minus the mean of 1979 and 1980 NMC temperature profiles collocated with the total ozone minimum for September 1 to October 30. Units are 2.0 °K.

of the springtime ozone decline persisted into the following year. Memory of the springtime depletion with a time scale of a year would lead to a secular trend for months that are outside the spring season.

When the vertical structure of the radiative temperature change in Figures 11.45 through 11.47 is compared to that of the NMC temperature trends in Figure 11.37, several interesting features are apparent. The radiative temperature changes caused by the ozone decline are centered near 100hPa. The vertical structure is in good agreement with the lower stratospheric trend for November, which also shows maximum trend over the pole at about 100hPa. During October, however, while a similar trend at 100hPa is observed, an additional and larger middle stratospheric trend appears with maximum decrease between the 30 and 10hPa levels. The cooling trend in the middle stratosphere during October is the opposite of the expected radiative warming at these levels and must be associated with altered wave driving. This altered wave driving in the middle stratosphere could be a dynamical response to the radiatively altered lower stratospheric temperature during October, or could arise for an entirely independent reason. The trends in eddy heat flux shown in Figure 11.43 show a significant trend for September, suggesting that the stratospheric temperature trends in the midstratosphere for the October average may be a response to reduced wave driving during the previous month.

11.3.3.2 Evidence for Upward Motion at High Latitudes in Spring

If the observed seasonal springtime ozone decline is to be explained in terms of mean vertical advection, the inferred upward velocity (about 5 km per month or 2 mm per second) cannot be measured directly, but must be inferred from observations of its effects. The most obvious procedure is to track stratospheric tracers. Upper tropospheric wave driving of the mean circulation is sufficient to maintain downward motion at high latitudes below about 10 km above the surface. This downward motion is fed by poleward flow at about the 300hPa level. Any reversed cell with rising over the pole would, therefore, be expected to be confined to the lower stratosphere, and to carry upward concentrations of tracers characteristic of about the 300hPa level or above.

Total Ozone

If the seasonal ozone depletion is indicative of rising motion in high latitudes, then there must be compensating subsidence and dynamically induced increase of the ozone column elsewhere at the same level. There is evidence for this occurring in southern midlatitudes. Stolarski et al. (1986) pointed out that, during September and October of 1979–1982, the midlatitude ozone maximum actually increased and that, in fact, the total ozone integrated over the area south of 44°S merely showed a slow increase. The integrated total ozone is shown in Figure 11.15. The minimum and maximum values south of 30°S for each of the years between 1979 and 1987 are shown in Figure 11.49. In the early years, the maximum increased at the same time that the minimum decreased. This midlatitude compensation is not evident in more recent years. The minimum value during October has continued to decline while the maximum has also decreased, a fact that could indicate one of two things: either there is no upward motion in high latitudes and no compensating ozone increase in midlatitudes and the decrease is caused by a photochemical sink, or the subsidence is occurring over a broader range of latitudes, so that its effects are less apparent. Some evidence for the latter interpretation comes from the calculations of Tung and Yang (1988, 1989), who found that the reverse meridional motion cell deduced from thermodynamic balance extended over a broader range of latitudes year by year and, consequently, that the midlatitude ozone compensation was not evident in later years.

ANTARCTIC OZONE CHANGES

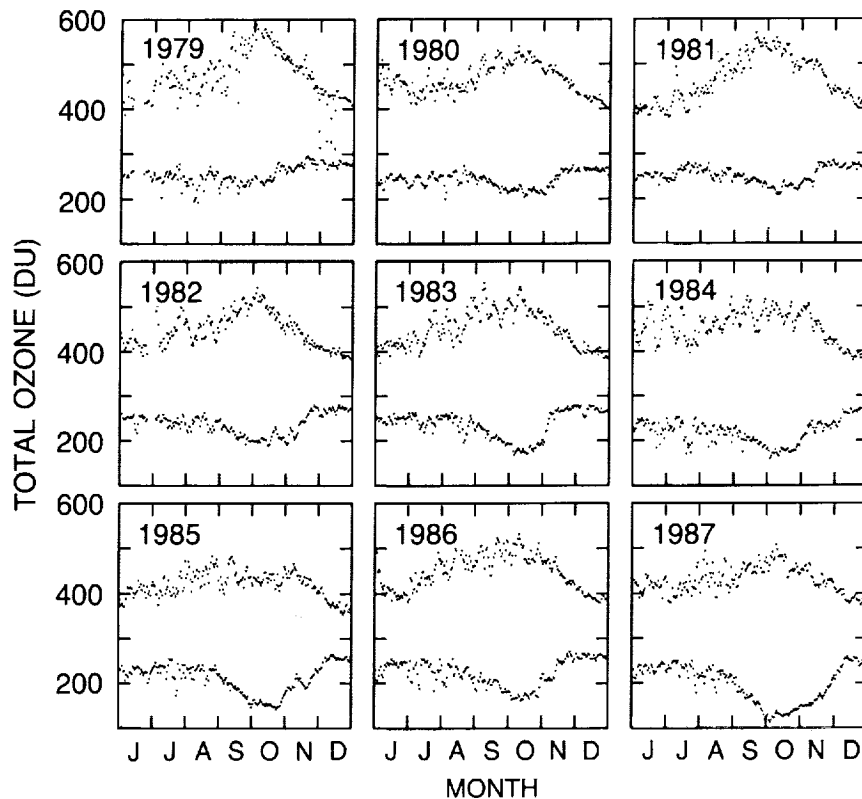

Figure 11.49. Maximum and minimum TOMS total ozone values south of 30°S, plotted as a function of day over the June–December period for each year between 1979 and 1987 (Schoeberl and Stolarski, 1988).

If the ozone depletion is a consequence of a dynamically induced circulation shift, rather than a change in the radiative driving at the end of the polar night, there is no reason that it should be confined to the polar cap. Indeed, the year-by-year depletion of zonal mean ozone in October shown in the TOMS data clearly extends well beyond the Antarctic to about 45°S (Schoeberl et al., 1986; Figures 11.12 and 11.13). Solomon (1988) argued that the midlatitude trend in the TOMS data is inconsistent with the absence of any such trend in the October Dobson data at MacQuarie Island, Invercargill, and Melbourne (Bojkov, 1986a). However, it is clear from the geographic structure of the TOMS trend (Figure 11.42) that this trend has a large planetary wave component that is entirely compatible with a similar structure in the temperature field. The planetary wave component in both the ozone and temperature trends corresponds to an eastward rotation of the October mean planetary wave field since 1979. This component of the ozone trend as measured by TOMS is so large that, while the zonal mean trend is negative in midlatitudes of the Southern Hemisphere, the trend in the South Pacific region is actually positive. The three midlatitude Dobson stations mentioned above are all in the Australia/New Zealand region and, in fact, as evident in Figure 11.42, close to a node in the TOMS trend. Therefore, the absence of a trend at these stations does not undermine the conclusion from the TOMS measurements that a substantial downward trend has occurred in the middle latitudes.

At first sight, the existence of this midlatitude signal appears to support the suggestion that the depletion is a response to a dynamically induced circulation shift, since the direct effects of a radiative change or of chemical depletion would be confined to polar latitudes. Even a localized depletion would be subject to dynamical redistribution during the spring warming, however. If

lower stratospheric ozone does indeed possess the long-term memory postulated above, such redistribution of a polar depletion could appear subsequently as a downward trend in mid-latitudes. Therefore, the latitudinal extent of the depletion may, in fact, not provide much insight into the underlying mechanisms of the depletion.

Temperature

By far the best monitored stratospheric quantity is temperature. Observations of temperature can be exploited to infer mean vertical motion through thermodynamic balance. Thus, the upward component can be calculated as the sum of two terms: diabatic (that required to balance radiative heating) and adiabatic (corresponding to the temperature tendency). During mid-winter, the Antarctic lower stratosphere is very close to radiative equilibrium; it seems likely that the diabatic term is upward there as the Sun rises at the end of the polar night. However, it is equally clear that the temperature rises in response to this heating. The two contributions to the calculation of vertical velocity are, therefore, of opposite sign and, in fact, very similar in magnitude. The calculation is thus a delicate one that, since the temperature tendency is reasonably well observed, rests primarily on the accuracy of the calculation of radiative heating.

Rosenfield and Schoeberl (1986) calculated a mean upward diabatic velocity of 0.4 mm per second in October 1980, but concluded that the net mean velocity was weakly downward. Rosenfield et al. (1988), however, deduced that the September mean motion was upward in the Antarctic lower stratosphere and of sufficient magnitude to explain the observed ozone depletion during 1980–1986, but pointed out the sensitivity of their calculation to the specification of surface temperature, tropospheric clouds, and stratospheric aerosols.

Whether or not the zonal mean motion is upward at the pole in spring, there is evidence of upward motion within the planetary wave field in the local temperature minimum. Since the (horizontal) spatial minimum of temperature is displaced from the vortex center (the geopotential minimum), there is a quasi-horizontal flow through the temperature minimum. The flow will, in fact, be almost isentropic (the Lagrangian time scales being short), and so there must be upward motion in the cold region. The implications of this for the Antarctic depletion problem do not appear to have been explored.

Aerosols

The observations of Hofmann et al. (1989) from McMurdo suggest downward motion of lower stratospheric aerosols in October 1986. Some uncertainty in this interpretation is introduced by the comparatively small number of samples taken and the possibility of fallout of the aerosol particles relative to the air.

Long-Lived Trace Gases

Long-lived trace gases of tropospheric origin, such as nitrous oxide (N_2O), F-11 and F-12, are relatively well mixed in the troposphere, but decrease with altitude in the lower stratosphere because they are photolyzed in the upper stratosphere. It would be expected, therefore, that transient upward motion leading to a decrease of ozone in the lower stratosphere would be accompanied by an increase in these gases in the same region in which the ozone depletion occurs. Spectroscopic measurements from McMurdo during spring 1986 showed low values of

ANTARCTIC OZONE CHANGES

N_2O within the vortex (Parrish et al., 1988; Farmer et al., 1987). To interpret such measurements in terms of vertical motion, the time evolution of vertical profiles through the spring season is required. It is possible, for example, that N_2O mixing ratios are low through the lower stratosphere in early spring, in which case the observation of low values would not be an indication of current downward motion, but merely of an earlier downward displacement of air. This appears to be the case, based on preliminary results from the 1987 Punta Arenas (Chile) aircraft campaign.

The ER-2 made 12 sorties out of Punta Arenas (53°S) between August 17 and September 22, 1987. The southernmost latitudes reached were between 68°S and 72°S and were usually inside the core of the vortex. Most tropospheric trace species decreased significantly as the core of the polar vortex was approached at the flight altitude (about 18 km) of the ER-2. Inside the core, N_2O , F-11, and F-12 were observed to remain relatively steady on constant potential temperature surfaces through September, while ozone declined significantly. The flight tracks of the ER-2 aircraft allow crude latitude versus potential temperature cross sections of N_2O and ozone to be drawn for each of the flights between August 17 and September 22, 1987. On the basis of these data, it is difficult to see how the ozone decline could be produced by a simple transport of mass, either by mean upwelling or eddy mixing. While these observations might be unrepresentative of the zonal mean behavior, they do not support the existence of a broad region of near-polar upwelling over this period, strongly suggesting the need of a photochemical sink to explain the ozone decline.

11.3.4 Summary

The polar lower stratosphere of the Southern Hemisphere is very different from that of the Northern Hemisphere. Strong zonal symmetry of surface conditions in the Southern Hemisphere produces a circulation that is much more symmetric and undisturbed by planetary wave activity than that of the Northern Hemisphere. This leads to conditions in the lower stratosphere in which the lower stratospheric polar vortex is relatively intense, maintaining its integrity throughout the winter season and well into spring. Dynamical modeling suggests that relatively little mixing occurs with air at other latitudes, at least at altitudes at which the vortex is sufficiently intense. The air within the polar vortex thus remains very cold and dynamically isolated. When the Sun returns to the South Pole in springtime, temperatures may be near or below radiative equilibrium. Solar heating might, therefore, play a more important role in driving the seasonal change there than it does in the Northern Hemisphere, where temperatures are kept well above radiative equilibrium by stronger wave forcing.

The observed Antarctic ozone decline occurs in the lower stratosphere, where transport by atmospheric motions has a major influence on the ozone-mixing ratio. It is reasonable to suggest that a relatively small climate shift in the Southern Hemisphere could produce a significant change in the total ozone over Antarctica, since the transport of ozone into that region during winter and spring is limited by dynamical constraints associated with the symmetry of the circulation and is very weak in comparison to the almost complete mixing that occurs in the Northern Hemisphere. It is conceivable that colder temperatures at the beginning of spring (produced by weaker wave forcing), or enhanced solar heating during spring (associated with increased aerosols), could lead to transient upwelling during the season that would contribute to the springtime ozone decline. But it is uncertain whether diabatic heating rates would, in reality, be both sufficiently large and suitably distributed in the vertical to produce a significant ozone reduction within the observational constraints.

Evidence from NMC analyses suggests that temperatures in the lower stratosphere over Antarctica have declined from 1979–1985 for the months of October and November; a corresponding decline in the wave driving for September is observed in the same data. Calculations of the radiative temperature change associated with the observed ozone decline suggest that the radiative effect of the ozone decline is comparable in magnitude to the observed trend. The radiative temperature change is largest at the 100hPa level, and its vertical structure in the lower stratosphere is very similar to that of the NMC trend for November. During October, a middle stratospheric temperature decline is observed, in addition to the lower stratospheric decline. This temperature decline in the middle stratosphere is not expected on the basis of radiation alone, but seems more likely to be associated with decreased wave driving during the previous month. Some combination of altered wave driving and radiative response to ozone changes seems necessary to explain the trend observed in NMC data over the 1979–1985 period.

Published attempts to model the springtime Antarctic ozone decline purely as a response to changed transport processes require that low-ozone air be moved into the lower stratosphere from below. Such a movement of air would also imply an increase of long-lived trace species of tropospheric origin such as N_2O , F-11, and F-12. Data from the instruments aboard the ER-2 aircraft show that these trace species remain relatively constant during September as ozone declines significantly, so that transport is unlikely to contribute significantly to the overall decline. These data support the hypothesis that a chemical sink for ozone is required within the polar vortex. However, the role of radiative and dynamical processes in establishing the conditions necessary for the ozone depletion and in controlling the temperature, cloudiness, and precise degree of isolation of the Antarctic ozone hole must be carefully considered.

11.4 CHEMICAL THEORIES AND OBSERVATIONS

11.4.1 Chemical Theories

11.4.1.1 Homogeneous Reactions

In their original paper, Farman et al. (1985) linked the ozone reductions in the Antarctic stratosphere to increasing levels of chlorine from CFC's and other halocarbons. The possible involvement of chlorine and bromine radicals in the ozone reductions has subsequently been the subject of intensive study using theoretical models and field measurements, particularly those made during the 1986 and 1987 ground-based National Ozone Expedition (NOZE) campaigns and the 1987 ER-2 and DC-8 aircraft campaign from Punta Arenas. It quickly became clear that the observed ozone depletion, which occurs predominantly in the lower stratosphere (below 25 km), could not be accounted for by the model chemical schemes in current use to describe the ozone budget in the global stratosphere. These schemes involve partitioning the chlorine between the catalytically active Cl_x species, i.e., Cl and chlorine monoxide radical (ClO), and the inert reservoir molecules hydrochloric acid (HCl), chlorine nitrate (ClONO₂), and HOCl, by a series of gas phase photochemical and thermal reactions (WMO, 1986). It should be noted that, while HOCl is normally thought of as a reservoir molecule, it can occasionally act as the active form of chlorine (e.g., Scheme A described later in this section). The inert reservoir molecules are the dominant forms of inorganic chlorine in the lower stratosphere at midlatitudes; thus, chlorine is not effective in destroying ozone. In addition, the fraction of chlorine tied up in the organic form is larger at midlatitudes than in the polar regions.

The bulk of the ozone (O_3) column and most of the observed loss over Antarctica occur at altitudes below about 22 km during the early spring weeks (end of August through September

ANTARCTIC OZONE CHANGES

and into early October). The low Sun angles characteristic of this season at these latitudes provide an insufficient supply of O atoms to permit catalytic cycles involving recombination of O₃ with O, which dominate the removal of O₃ at midlatitudes. A number of chemical schemes involving ClO, serving as a catalyst for recombination of O₃ with itself, have been suggested and assessed using model calculations; the three most important are:

Scheme A

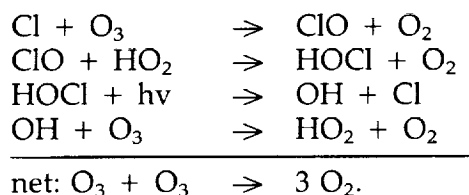

The reactions in Scheme A were suggested as an explanation of the decrease in Antarctic ozone by P. Solomon et al. (1987). The importance of this scheme appears to be less than Schemes B and C because of the relatively slow rate of photolysis of HOCl. The HO_x radicals produced by photolysis of HOCl in this cycle may also lead to ozone loss through the cycle:

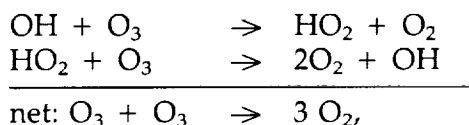

but this is apparently less important than the reactions involving ClO.

Scheme B

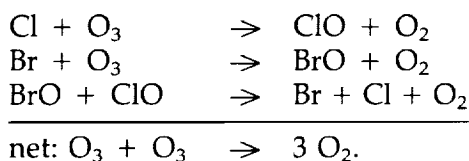

Scheme B was favored by McElroy et al. (1986a). An additional channel for the BrO + ClO reaction is the formation of chlorine dioxide, OClO;

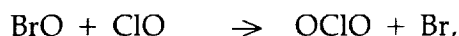

which could accumulate and become an important form of active chlorine at night. In daylight, OClO is rapidly photolyzed by visible light:



This sequence produces no net ozone depletion from the BrO + ClO reaction occurring through this channel. However, since this is the only known reaction leading to OClO production in the stratosphere, the observation of significant concentrations of OClO during the Antarctic spring would provide indirect evidence for elevated abundances of ClO and the bromine monoxide radical (BrO), implying that they are involved in the chemical destruction of ozone (Tung et al., 1986; Rodriguez et al., 1986). While other possible OClO formation mecha-

nisms may be possible, such as the photolysis of the Cl_2O_2 dimer, none has yet been demonstrated (discussed later).

Another possible reaction pathway for ClO and BrO leads to the formation of BrCl (Toohey and Anderson, 1988):

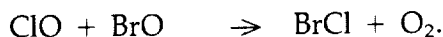

This reaction would not affect the efficiency of Scheme B because the BrCl would rapidly photolyze during the daytime to produce chlorine and bromine atoms:



which then rapidly reform ClO and BrO. The reaction would, however, reduce the production of OClO at night because atomic bromine, and hence BrO, would not be reformed and the efficiency of the cycle producing OClO would be reduced (Salawitch et al., 1988a). Current laboratory work is aimed at improving knowledge of the rate and branching ratio for the BrO + ClO reaction for atmospheric conditions. This promises to reduce the uncertainties in the chemistry of the mixed BrO and ClO system. Several studies have confirmed that OClO formation is a major channel from the BrO + ClO reaction (Clyne and Watson, 1977; Friedl and Sander, 1987; Sander and Friedl, 1987; Toohey and Anderson, 1988).

Scheme C (a)

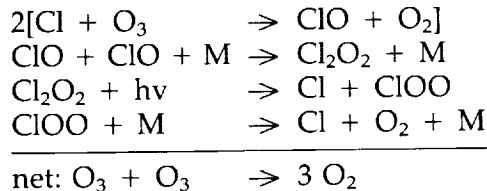

Scheme C (b)

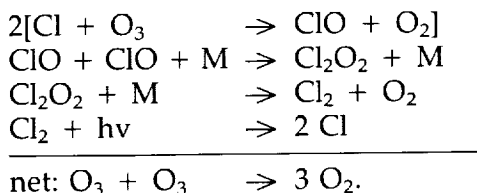

Molina and Molina (1987) were the first to draw attention to the possible importance of the ClO dimer molecule, Cl_2O_2 , in Scheme C (a). Rodriguez et al. (1986) and McElroy et al. (1986b) have shown that a combination of Schemes B and C can account for the magnitude of the observed loss of O_3 , provided the concentration of ClO is high (close to 1 ppbv), and that for Scheme B to play a dominant role requires an abundance of BrO (in excess of about 10 pptv). Key questions concerning Scheme C (a) are the rate of formation of the Cl_2O_2 dimer, the rate of photolysis, and the identification of the photolytic products of the Cl_2O_2 dimer, none of which is well established (Molina and Molina, 1987; Hayman et al., 1986). Preliminary data suggest that the dimer does photolyze rapidly (Cox and Hayman, 1988; Molina and Molina, 1987). In addition, preliminary and somewhat indirect evidence has been obtained for the production of

ANTARCTIC OZONE CHANGES

atomic Cl in the photolysis of Cl_2O_2 , rather than ClO and ClO, or Cl and OClO (Cox and Hayman, 1988). If the Cl_2O_2 dimer were to photolyze by either of the latter routes, there would be no catalytic removal of ozone. Consequently, it is essential to define the rate of ClO dimer (Cl_2O_2) formation and the photolysis products of dimer decomposition because only one of several possible routes leads to ozone destruction. Molina and Molina (1987) have proposed an alternate cycle, Scheme C (b), involving the Cl_2O_2 dimer. They propose that the Cl_2O_2 dimer could dissociate thermally to produce molecular chlorine, which would rapidly photodissociate into atomic chlorine and molecular oxygen. The rate and product distribution of the thermal dissociation of the Cl_2O_2 dimer are uncertain, but it appears improbable that this mechanism would be important.

Each of the ozone loss schemes discussed above requires significant release of ClO_x radicals from the main chlorine reservoirs, HCl and ClONO_2 , which current models, using gas-phase chemistry alone, do not predict. Several theories have been proposed to account for the enhanced ClO abundance. P. Solomon et al. (1987) and McElroy et al. (1986a) point to the possible importance of heterogeneous processes converting the inert reservoir species of chlorine, HCl and ClONO_2 , to more active forms of chlorine on the surfaces of PSC's. These processes are discussed in Section 11.4.1.3. Crutzen and Arnold (1987) also argued the importance of heterogeneous loss processes involving the PSC's, focusing particularly on the interactions of the nitrogen molecules N_2O_5 and nitric acid (HNO_3). These authors offer an alternative explanation for the release of ClO_x from HCl—through the presence of enhanced abundances of OH. These enhanced OH densities in the polar spring are attributed to a nighttime cosmic ray source of HO_x , augmented by coupling with methane (CH_4) oxidation when sunlight returns.

Krueger et al. (1987) proposed that abnormally high ClO_x and BrO_x radical concentrations could result from increased photolysis rates of the halocarbon source gases due to heterogeneous photolysis on the surface of PSC's and aerosols. Their argument contains several rather tenuous assumptions that are not supported by appropriate experimental laboratory data.

Callis and Natarajan (1986) proposed that ozone loss in the polar stratosphere is catalyzed by abnormally high levels of NO_x . This theory links the currently observed ozone depletion to the 1979 solar maximum, resulting, it is claimed, in the production of large amounts of NO in the mesosphere and thermosphere that would then be transported down to the lower stratosphere. Obviously, if this mechanism were to be correct, then the ozone hole should be periodic. The actual catalytic cycle proposed was the classic NO_x cycle:

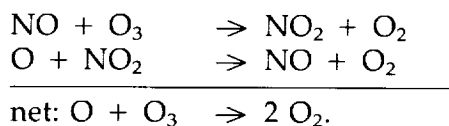

Several of the gas phase thermal and photochemical reactions not included in previous models of stratospheric chemistry attain new significance in the context of the Antarctic ozone problem, as discussed above. Knowledge of the rate coefficients and pathways of some of these reactions is far from complete. In addition, the extremely low temperatures prevalent in the stratosphere over Antarctica are often significantly outside the range over which measurement of many of the elementary reactions in the HO_x , NO_x , and ClO_x cycles have been carried out. Considerable error may result in the extrapolation of the rate coefficients from higher temperatures, particularly as many of the reactions exhibit non-Arrhenius behavior and have negative

temperature dependencies, for example, $\text{HO}_2 + \text{O}_3$, $\text{HO}_2 + \text{ClO}$, $\text{HO}_2 + \text{HO}_2$, and $\text{HO}_2 + \text{CH}_3\text{O}_2$.

11.4.1.2 Character and Role of Polar Stratospheric Clouds

The composition of PSC's is a matter of controversy. It was thought, until recently, that the clouds were composed mainly of water ice, and that individual particles grew by accretion of H_2O on nuclei of hydrated H_2SO_4 (Steele et al., 1983). Toon et al. (1986) argued that the opacity of PSC's would be much larger than that observed if the clouds were composed primarily of H_2O . Toon et al. and Crutzen and Arnold (1986) simultaneously suggested that PSC's might be composed mainly of nitric acid trihydrate ice, $\text{HNO}_3 \cdot 3\text{H}_2\text{O}$; they discussed some of the effects to be expected from incorporation of these species into the condensed phase. Toon et al. also suggested that significant quantities of HCl could condense in PSC's. A direct consequence of cloud formation would be reduction in the gas phase concentrations of the major reservoir species for odd nitrogen and inorganic chlorine. In addition, the presence of HNO_3 and HCl in the solid phase could be important in promoting heterogeneous chemical reactions. If the particles grew large enough to fall out, acids could be removed from the local environment.

McElroy et al. (1986b) presented an alternative analysis of the thermodynamics of H_2O - HNO_3 mixtures that supported the original assertion that condensation in PSC's could provide a significant sink for stratospheric HNO_3 gas. Condensation at temperatures below about 193 K probably involves formation of crystalline phases consisting of mixtures of $\text{HNO}_3 \cdot 3\text{H}_2\text{O}$ and $\text{HNO}_3 \cdot \text{H}_2\text{O}$. Condensation of even a few ppb of H_2O should result in essentially complete removal of gas phase HNO_3 . Condensation of HCl requires somewhat lower temperatures, and a solid solution is formed rather than a crystalline hydrate (Wofsy et al., 1988). A reduction in gas phase H_2O by 1 ppm should lead to a reduction in HCl of more than 99 percent. Fallout of particles can provide significant localized sinks for HNO_3 , H_2O , and, possibly, HCl and N_2O_5 . The first large particles to fall might be expected to be rich in HNO_3 . The amount of HNO_3 present in the precipitation might be reduced considerably when an air parcel undergoes subsequent condensation. Precipitation would leave the environment depleted in HNO_3 , HCl , and H_2O . The mixing ratios of HNO_3 and HCl in the lower stratosphere are expected, under normal conditions, to rise with increasing altitude. Evaporation of precipitating particles at lower altitudes could be associated with significant enhancement of HNO_3 , and possibly HCl , at the deposition altitudes, with small related changes in the abundance of H_2O . There is also a possibility that HNO_4 , H_2O_2 , and other reservoir molecules could be incorporated and precipitated in the PSC's.

However, a recent study by Poole (1987), with experimental evidence given by Poole and McCormick (1988), has supported the suggestion that these particles have more than one growth mode delineated by temperature. A stage of nitric acid trihydrate deposition is interposed between the two stages of cloud growth assumed in earlier PSC studies—i.e., between the aerosol droplet precursors and ice particles. Figure 11.50 shows the calculations for three temperatures: the end of the precursor stage at about 195 K; just prior to the end of the $\text{HNO}_3 \cdot 3\text{H}_2\text{O}$ deposition stage at about 191 K; and below the frost point at about 189 K. More than 80 percent of the nitric acid and 30 percent of the water vapor supplies may be sequestered in the relatively large 8 μm diameter PSC particles formed at and below the frost point temperature. These large particles would fall at a rate of about 2 km per week (fast enough to produce the October cleansing shown in Figure 11.28), suggesting that PSC's may act as a sink for stratospheric trace gases, in this case HNO_3 and H_2O . It might be possible for other gases to condense like HCl and, at a minimum, to redistribute certain stratospheric gases in altitude.

ANTARCTIC OZONE CHANGES

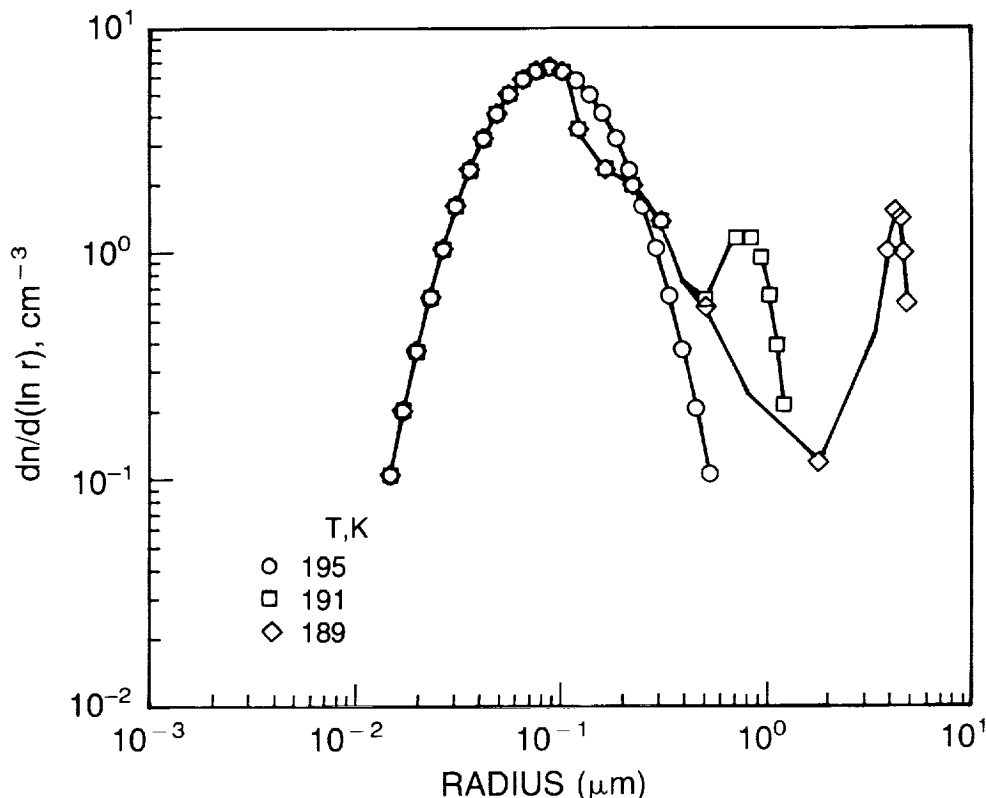

Figure 11.50. Evolution of the nonvolcanic particle size distribution at 70 mb with temperature. Shown are the size distributions at 195 K, 191 K, and 189 K, assuming a cooling rate of 0.5 K/day.

11.4.1.3 Heterogeneous Reactions

The existence of PSC's composed of H_2O , HNO_3 , and HCl suggests the possibility of important multiphase (for "heterogeneous") chemical processes. Photochemical theories of the Antarctic ozone hole presume some heterogeneous chemical effects, or at least the microphysical effect of acid condensation and removal. However, not all of these treatments have a quantitative description of specific processes and reaction rates, mainly because of a lack of laboratory data on such reactions and the inadequacy of theoretical approaches in defining the kinetics.

The occurrence of heterogeneous reactions of ClONO_2 with H_2O and HCl and of N_2O_5 with water have been known in laboratory systems for some time. The determination of their significance for atmospheric chemistry and their representation in kinetic models presents a considerable challenge.

The heterogeneous processes of current interest include:

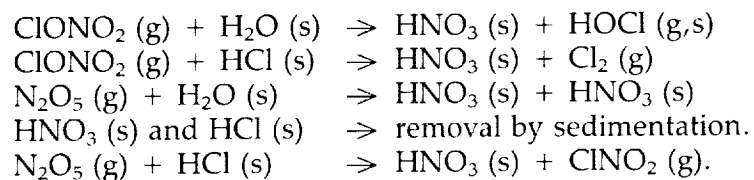

The efficiency of a heterogeneous reaction is often expressed in terms of the collision efficiency for reaction, g . This is the fraction of the kinetic encounters of a gas molecule with a

surface that result in the reaction of interest at the surface. In reality, chemical reactions on solid (ice) particle surfaces are generally multistep processes involving:

- Transport of the reactant species to the surface by diffusion and kinetic motion.
- Absorption on the surface (with physical or chemical bonding).
- Diffusion of the reactants on the surface, or within the bulk of the solid.
- Encounter of the reactants on the surface, with formation of activated complexes and reaction to form products.
- Diffusion of the product species on the surface, or within the solid.
- Possible secondary reactions of product species on the surface.
- Desorption of the product molecules and transport of the products from the vicinity of the particle.

Accordingly, such heterogeneous reactions are much more complex mechanistically than homogeneous gas phase reactions. Often, reactions that are slow in the gas phase can be catalyzed on certain surfaces due to the interaction of the reactants with the surface, which lowers the activation barrier significantly. Nevertheless, such reaction mechanisms have rarely been studied in detail. In the case of heterogeneous reactions of atmospheric interest at low temperatures on HNO₃ and HCl ices, the reaction mechanisms are unknown. Wofsy et al. (1988) pointed out that since a number of chemical bonds are rearranged in the heterogeneous reactions discussed earlier, the lack of a significant activation energy implies a catalytic reaction mechanism. They suggested that the reactions may be acid catalyzed, with protonation of ClONO₂ and N₂O₅ giving rise to incipient Cl⁺ or NO₂⁺, leaving groups,

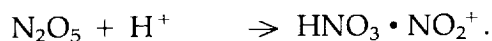
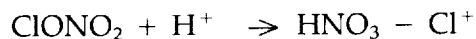

These powerful oxidant groups should react rapidly with Cl⁻, which can diffuse rapidly through the ice (Molina et al., 1987) to the reaction site on the particle surface. The reaction is essentially an ion-ion recombination, which may be expected to proceed rapidly with no activation barrier. Rowland (1988) also suggested that the reactions might involve partially solvated Cl⁻ ions in an ice matrix. Because these reactions are rapid, with values of *g* (collision efficiency) greater than 0.1, it is probably not necessary to understand the details of the heterogeneous reactions to simulate the chemical processes responsible for the depletion of ozone in Antarctica. Accordingly, while a simple representation based on the collision model using empirical data for *g* is the best that can be done now, it is also appropriate.

The overall rate of a reaction on PSC particles can be estimated using the observed optical extinction of the PSC's (which is related to the available reaction surface area of the PSC's) by the following approximate relation (e.g., Toon et al., 1986):

$$t_R = 1 / (k_e v_{th} g),$$

ANTARCTIC OZONE CHANGES

where t_R is the reaction time constant (s), k_c is the PSC extinction (cm^{-1}), g is the collision efficiency, and v_{th} is the thermal velocity of the impinging reactant molecules (cm/sec). Since $k_c \sim 10^{-7} - 10^{-8}/\text{cm}$ and $v_{th} \sim 10^4 \text{ cm}/\text{s}$, $t_R \sim 10^3 - 10^4/g \text{ s}$. Some typical time constants derived in this way are displayed in Table 11.3.

Table 11.3 Heterogeneous Reactions in PSC's

Reaction	Collision Efficiency, g	Time Constant for Reaction on PSC's (3) (seconds)	
		Extinction $10^3/\text{km}$	Extinction $10^2/\text{km}$
$\text{ClONO}_2 + \text{H}_2\text{O} (\text{s}) -$	3.2×10^{-4} (1)	3×10^7 (3)	3×10^6 (3)
$\text{HNO}_3 + \text{HOCl}$	0.02 (2)	5×10^5	5×10^4
	0.008 (7)	1.3×10^6	1.3×10^5
$\text{ClONO}_2 + \text{HCl} \cdot \text{H}_2\text{O} (\text{s}) \rightarrow$ $\text{HNO}_3 + \text{Cl}_2$	0.05	2×10^5 (3)	2×10^4 (3)
$\text{N}_2\text{O}_5 + \text{H}_2\text{O} (\text{s}) \rightarrow$	3.8×10^{-5} (4)	3×10^8 (3)	3×10^7 (3)
2HNO_3 (?)	1×10^{-3} (5)	1×10^7	1×10^6
$\text{ClO} + \text{H}_2\text{O} (\text{s}) \rightarrow$	3.7×10^{-10} (3220/T)	3×10^6 (3)	3×10^5 (3)
$\text{HCl} + ?$	3.6×10^{-3} @ 200 K (6)		
$\text{HCl} + \text{H}_2\text{O} (\text{s}) \rightarrow$	>0.1 (8)	2.5×10^4	2.5×10^3
$\text{N}_2\text{O}_5 + \text{HCl} \rightarrow$ $\text{ClONO}_2 + \text{HNO}_3$			

1. Rossi et al. (1987); for a 95% H_2SO_4 -5% H_2O surface at 300 K.

2. Molina et al. (1987); for pure ice, or ice exposed to HCl vapor, at 200 K.

3. The extinction coefficient, K_e (km^{-1}), is related to the reaction time constant, t , by the expression, $t = 1/(k_c v_{th} g)$, where v_{th} = molecular speed and g is the collision efficiency.

4. Baldwin and Golden (1979); lower limit for a 95% H_2SO_4 -5% H_2O surface at 300 K.

5. Estimate for nearly pure ice at 200 K.

6. Martin et al. (1980) for 75% H_2SO_4 -25% H_2O surface at temperatures down to 230 K.

7. Tolbert et al. (1987) for pure ice at 185 K.

8. Worsnop et al. (1987)

The most significant new work is the studies of ClONO_2 reactions on ice and HCl-ice by Molina et al. (1987) and Tolbert et al. (1987), and studies of the sticking coefficients of HCl on ice particles by Worsnop et al. (1987). Recent measurements have shown that sticking coefficients for HCl on ice particles ($g > 0.1$; Worsnop et al., 1987) and for chlorine nitrate on an ice matrix containing HCl ($g > 0.05 - 0.1$; Molina et al., 1987) are much higher than expected based on the limited data, as shown in Table 11.3, where values of collision efficiencies of $\sim 10^{-3}$ to 10^{-5} are reported from earlier studies (e.g., the results of Baldwin and Golden, 1979).

Molina et al. (1987) also derived direct evidence of the following facts:

- HCl vapor readily diffuses into water ice crystals at low temperatures, forming solid solutions that can approach several percent or more of HCl by weight (also see Wofsy et al., 1988); this confirms that HCl may condense directly into PSC ice particles in the polar winter stratosphere.
- The dissolved HCl in solid solution is very mobile within the ice crystal lattice; thus, as in aqueous solutions, the mobility of the HCl molecule greatly enhances its reaction with reactant species on the surface.
- The HNO₃ molecules formed by ClONO₂ reactions with ice and HCl ice remain in the condensed phase; hence, the odd nitrogen involved in forming both HNO₃ and ClONO₂ can be sequestered in the ice and removed from the local environment. In terms of the polar stratosphere, this result also implies that HNO₃ vapor could condense independently as nitric acid PSC's in accordance with the theories proposed by Toon et al. (1986) and Crutzen and Arnold (1986).
- The HOCl molecules formed by the reaction of ClONO₂ and H₂O (ice) are not as tightly bound to the ice surface as HNO₃ and can desorb in minutes (at 200 K); thus, this process probably does not sequester "reactive" chlorine species.

The presence of PSC's, which are a common feature of the nighttime Antarctic stratosphere, may enhance the rate of a number of reactions involving chlorine and nitrogen species. Denitrification of the stratosphere facilitates ozone destruction by ClO_x and BrO_x catalysis because the reactions involving NO and NO₂ (nitrogen dioxide), e.g.,

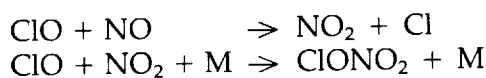

and

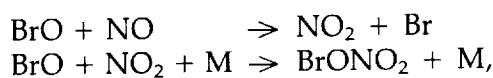

which reduce the concentrations of ClO, are reduced in importance. However, a number of questions regarding multiphase processes require additional study, including:

- The vapor pressures of HNO₃, H₂O, and HCl over mixed ices of these substances at temperatures as low as 180–185 K; the nature of the condensed phases (e.g., the composition and crystal forms) must also be determined.
- The dependence of the heterogeneous reactions described above on temperature and ice composition must be determined quantitatively; the reaction mechanisms must be better delineated.
- Evidence of other global heterogeneous chemical effects should be sought, particularly the possibility of particle-catalyzed chemistry enhanced by volcanic eruptions.

ANTARCTIC OZONE CHANGES

11.4.1.4 Summary

All current theories that attempt to describe ozone loss in the Antarctic stratosphere in terms of catalytic chemical destruction have the following features:

- Drastic reduction in NO_2 abundance resulting from removal of odd nitrogen (NO_y) as HNO_3 in the condensed phase of PSC's.
- Catalytic cycles involving HOCl , Cl_2O_2 , and BrO catalyzing the recombination of O_3 with itself.
- Release of a substantial fraction of the ClO_x contained in the reservoir molecules HCl and ClONO_2 , either by heterogeneous reactions in PSC's or by enhanced OH abundance.

11.4.2 Observations Relevant to Testing the Chemical Theories

11.4.2.1 Observational Data Base

Our understanding of the chemical composition of the springtime Antarctic atmosphere increased dramatically during 1986 and 1987. Observations of the column content (and in some instances, the vertical distribution) of a large number of species, including O_3 , ClO , OCIO , ClONO_2 , HCl , hydrofluoric acid (HF), NO_2 , and HNO_3 , were made from McMurdo in 1986. These observations clearly demonstrated that the chemical composition of the Antarctic stratosphere in springtime was highly perturbed compared to predictions based on the currently accepted chemical and dynamical theories that are applicable to midlatitudes. The distribution of chlorine species is significantly different from that observed at midlatitudes, as are the abundance and distribution of nitrogen species. At present, it is not clear whether the abundance of total inorganic chlorine is perturbed relative to that expected, or just the partitioning. The preliminary findings from the 1987 ER-2 and DC-8 aircraft campaign based in Punta Arenas are consistent with the observations made last year from McMurdo, and provide a more detailed picture of the chemical composition, dynamic structure, and the complex interplay between them. In addition, it was observed that the amount of total water within some regions of the vortex is significantly lower than anticipated.

The spatial and temporal distribution of a large number of relatively short-lived chemical constituents that play a key role in the chemical reactions affecting ozone abundance were measured from both the ER-2 and DC-8. Instruments aboard the ER-2 gave measurements of the distributions of O_3 , ClO , BrO , total NO_y , nitric oxide (NO), and water in the vicinity of the aircraft at altitudes ranging from 12 to 18.5 km above Earth's surface—well into the altitude region where ozone is undergoing depletion. Instruments aboard the DC-8 measured the abundances of H_2O and O_3 in the vicinity of the aircraft, the vertical distribution of O_3 for approximately 10 km above the aircraft, and the total column amounts of O_3 , HCl , ClONO_2 , OCIO , BrO , HF , NO , NO_2 , HNO_3 , and possibly HOCl , as well as of a number of other constituents above the aircraft altitude.

The temporal and spatial distributions of long-lived chemical tracers and dynamical variables were measured to understand atmospheric motions. These included measurements of N_2O , CH_4 , chlorofluorocarbons 11 (CFCl_3) and 12 (CF_2Cl_2), carbon tetrachloride (CCl_4), and methylchloroform (CH_3CCl_3). In situ measurements of all of these species were made from both the ER-2 and DC-8, and column measurements of most of them from the DC-8. In addition, the

vertical distribution of the chlorocarbons provided information about the vertical distribution of inorganic chlorine. Additionally, atmospheric pressure, temperature, lapse rate, and winds were measured aboard the ER-2 to determine the state variables and dynamical structure of the atmosphere.

The size distribution, abundance, and composition of particles were determined by instrumentation aboard the ER-2, and the vertical distribution of aerosols from 12 to 28 km was measured by the DC-8 lidar in an effort to understand the role of heterogeneous processes.

11.4.2.2 Comparison of Theory and Observations

The weight of observational evidence from McMurdo and the aircraft campaign strongly suggests that both chemical and meteorological mechanisms perturb the ozone. Additionally, it is clear that meteorology sets up the special conditions required for the perturbed chemistry. It is evident from the 1987 ER-2 flights that the region of dehydrated and denitrified air maintained a sharply defined latitude gradient throughout most of the campaign. Based on a purely meteorological definition, the vortex edge would be well outside the dehydrated, denitrified region. The meteorological flow must, therefore, have been such as to maintain a kind of "containment vessel" in which the perturbed chemistry could proceed without being influenced by mixing in more normal stratospheric air from outside or below. The concept of mixing at the region of sharp latitudinal gradient is important because it has the potential to supply nitrogen oxides, which would tend to decelerate the chlorine chemistry. The meteorology is thus important in both the termination and initiation phases.

11.4.2.3 Observations of Halogen Species

The data reported from McMurdo in 1986 demonstrated that while the abundance of total chlorine was consistent with that expected, the partitioning of Cl_x was highly perturbed compared with that observed at midlatitudes. The concentrations of HCl were low (Farmer et al., 1987), whereas the concentrations of OClO and ClO were significantly elevated (S. Solomon et al., 1987). Somewhat elevated concentrations of ClONO_2 were also observed (Farmer et al., 1987).

The in situ ER-2 data taken from late August until the end of September 1987 at about 18.5 km (the highest altitude at which the plane was flown) showed that the abundance of the chlorine monoxide radical within the polar chemically perturbed region was elevated by a factor of more than 100 relative to that measured at midlatitudes. The abundance of ClO at local solar noon ranged between 0.5 and 1 ppbv. However, the abundance of ClO was observed to decrease rapidly toward lower altitudes, and, while no data were taken at higher altitudes, the observed increase in the abundance of ClO from lower altitudes, coupled with the observed low column abundances of HCl, suggests that the ClO abundance may increase somewhat at altitudes above 18 km. In addition to the steep decrease in ClO abundance at lower altitudes, the abundance of ClO was also observed to decrease dramatically outside the chemically perturbed region. These observations are consistent with the low vertical resolution and low signal-to-noise microwave emission measurements made at McMurdo in 1986 (deZafra et al., 1987; S. Solomon et al., 1987), which reported ClO abundances of about 1 ppbv in the lower stratosphere (Figure 11.51) during September. Figure 11.52, from deZafra et al. (1987), shows the observed temporal behavior of ClO during September and October 1986 from McMurdo. P. Solomon et al. (1987) also reported the diurnal behavior of ClO as shown in Figure 11.53.

ANTARCTIC OZONE CHANGES

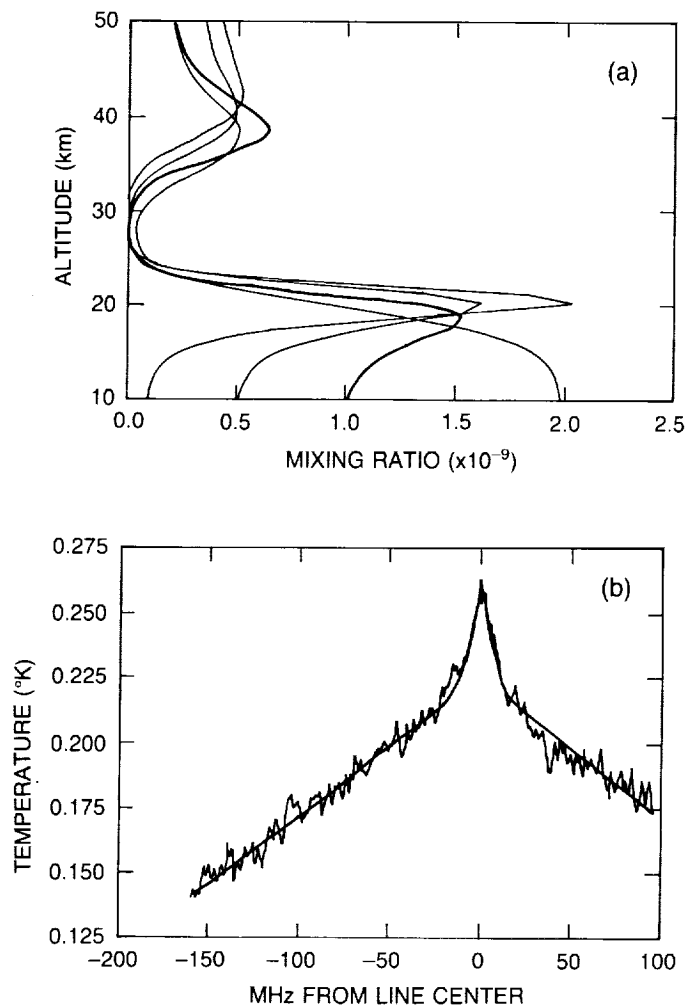

Figure 11.51. Ground-based mm-wave spectral data from McMurdo Station, taken in September 1986. (a) result of four deconvolutions of the ClO emission line at 278 GHz shown in lower panel. Profiles shown result from initial mixing ratio choices of 0.1, 0.5, 1.0, and 2.0 ppbv, constant from 10–60 km, as inputs to the deconvolution algorithm. The initial choice remains unaltered in the algorithm below ~ 12 km and dominates the profiles up to ~ 18 km, but all deconvolutions yield a clearly bimodal structure with a large low-altitude component of ClO the emphasized profile yields the fit to data shown in the lower panel. (b) ClO emission line averaged over a 7-hour period, starting 4 hours after dawn at 20 km and ending 4 hours before sunset at 45 km. Data taken on a nearly daily basis have been averaged over the period 1–22 September. (From de Zafra et al., 1987.)

The in situ aircraft data demonstrated that ClO existed during September 1987, within the chemically perturbed region of the vortex near 18.5 km, at abundances sufficient to destroy ozone if our current understanding of the chlorine–ozone ClO dimer catalytic cycle is correct (Molina and Molina, 1987). The rate of ozone decrease during September at the ER-2's highest altitudes was consistent with simultaneously observed concentrations of ClO. However, as mentioned earlier, our present understanding of key chemical reaction rates and photodissociation products within the catalytic process is incomplete. Once the results of ongoing laboratory studies become available, these in situ ClO data will allow the chemical mechanism to be defined quantitatively and its consequences better understood.

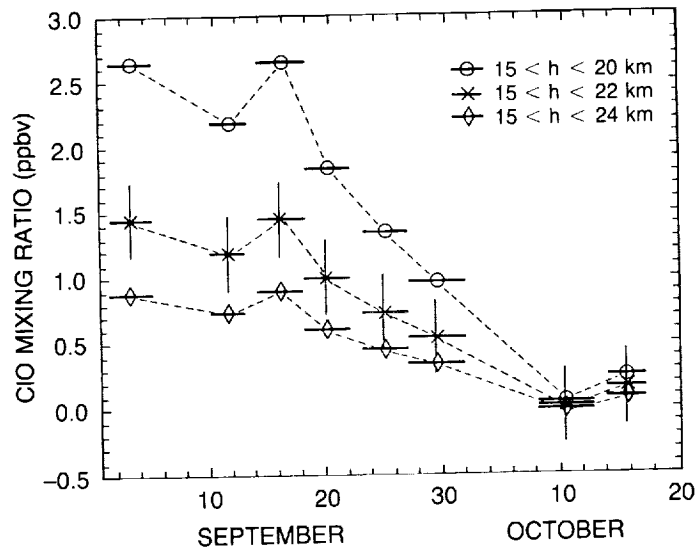

Figure 11.52. Observed trend in lower atmospheric ClO component over McMurdo Station during the period September 1–October 16, 1986. Left-hand scale gives mixing ratio in the form of an average over an altitude span, as determined from line-shape deconvolutions. Different mixing ratio values on a given date result from different assumptions concerning thickness and upper altitude limit of the low-altitude ClO component. Data for October 14–16 are of poorer quality but are included for completeness. Horizontal bars represent averages over 3–5-day periods. (From P. Solomon et al., 1987.)

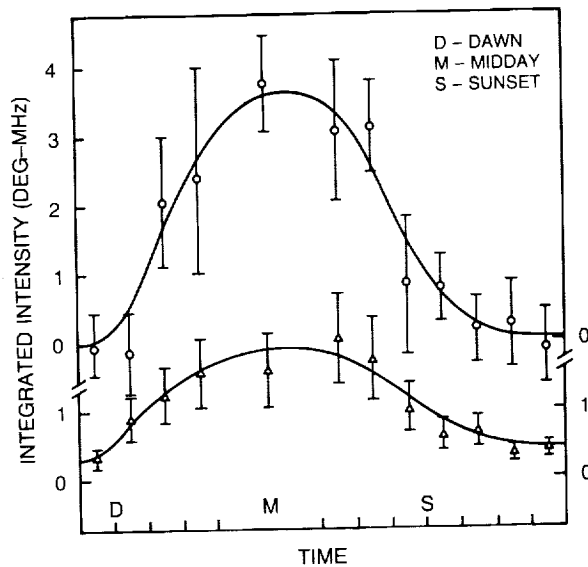

Figure 11.53. Diurnal variation of integrated ClO emission line intensity measured at McMurdo Station in 1986. Data were divided into 2-hour time intervals for analysis, except for the longer midday block. Points D, M, and S along the time axis mark dawn at 20 km, midday, and sunset at 45 km, respectively. The upper curve represents diurnal behavior of the low-altitude component only, integrated over ± 100 MHz around the line center. The lower curve represents the upper altitude component only, integrated over ± 50 MHz around the line center. A significant fraction of the intensity of the total low-altitude line is lost by the limited bandwidth available for integrating the pressure-broadened line. Curves are freehand fits, and error bars represent one standard deviation uncertainties in retrievals. (From de Zafra et al., 1987.)

ANTARCTIC OZONE CHANGES

There is another line of observational evidence consistent with ozone destruction by chlorine catalysis. In August, a consistent positive correlation between ClO and O₃ was observed, whereas by mid-September, as the ozone concentration was dropping at ER-2 altitudes, a strong anticorrelation developed between ClO and O₃. The anticorrelation was usually present on both large and small scales within the chemically perturbed region.

One observation that is currently difficult to understand is the sharp decrease in the abundance of ClO at lower altitudes where downward trends in ozone were observed. This could be due to a lack of understanding of either the abundance or partitioning of ClO_y, or to dynamical effects. Lack of observations of reactive hydrogen-containing radicals, hydroxyl (OH), and hydroperoxy (HO₂), currently prevents an assessment of their role in the conversion of chlorine reservoir species to ClO. Measurements of HOCl would partly assist in understanding the ClO_y / HO_x interaction.

Chlorine dioxide, which is most likely formed in a reaction sequence involving the ClO radical, was observed both day and night from McMurdo in 1986 at highly elevated concentrations compared to those at midlatitude (P. Solomon et al., 1987). Figure 11.54 shows the observed nighttime vertical column abundance of OClO using direct moonlight visible absorption spectroscopy. Figure 11.55 shows the temporal variation of the vertical column of OClO observed at twilight from August 26, 1986, to October 21, 1986. The preliminary analyses of the 1987 DC-8 and McMurdo observations are consistent with measurements made from McMurdo in 1986. The observed OClO diurnal variation provides useful constraints on the chemical mechanisms controlling the reactive chlorine and reactive bromine levels. Based on preliminary

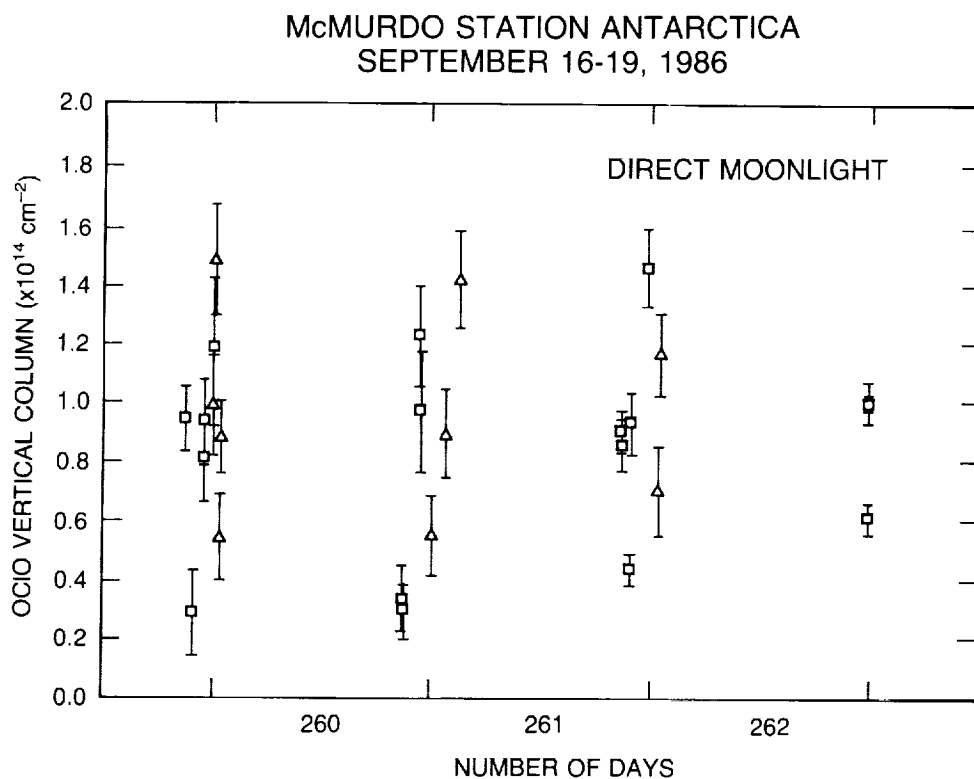

Figure 11.54. OClO vertical column over McMurdo from September 16–19, 1986, measured by direct moonlight. (From S. Solomon et al., 1987.)

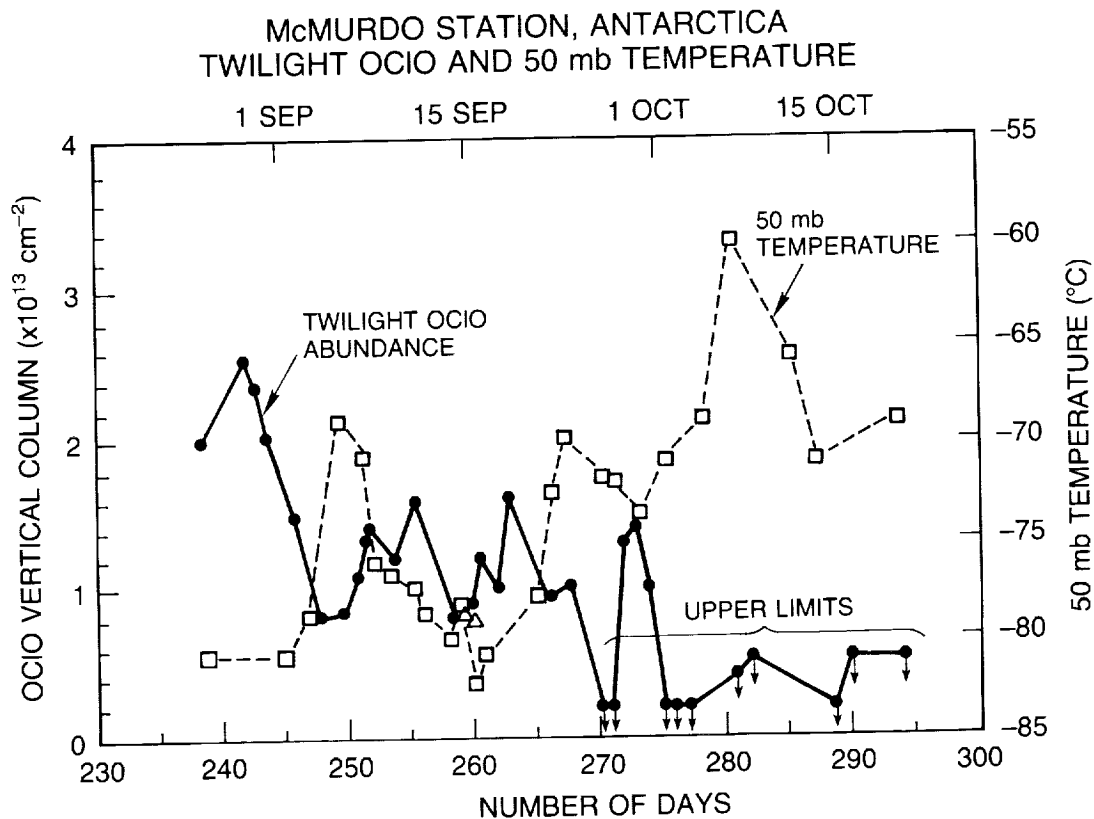

Figure 11.55. OCIO vertical column over McMurdo from late August through mid-October 1986 measured during twilight. Also shown is the 50 mb temperature. (From S. Solomon et al., 1987.)

McMurdo data from this year and last, the observed absolute abundances and the diurnal behavior of OCIO may be difficult to rationalize with the present chemical mechanisms, particularly in light of new observations that the abundances of BrO are only a few pptv at ER-2 flight altitudes. In addition, it should be noted that there are still significant uncertainties, which are currently being resolved, for the absolute rate constant and branching ratio of the BrO + ClO reaction at lower stratospheric Antarctic conditions. Salawitch et al. (1988a) have simulated OCIO abundances, both day and night, for a range of BrO abundances, taking into account different branching ratios for the ClO + BrO reaction. They reported that the observed diurnal variation of OCIO is consistent with the ClO + BrO reaction being the sole source of OCIO if the reaction has a channel forming BrCl, and if the abundance of BrO is about 10 pptv near 18 km. They concluded that if the ClO + BrO reaction did not have a pathway forming BrCl between 3.5 percent and 14 percent of the time, then the diurnal behavior of OCIO implies an additional source of OCIO in twilight. This analysis depends critically upon the assumed altitude profiles for the concentrations of both ClO and BrO. Consequently, once the aircraft and McMurdo data become available for both ClO and BrO, a critical analysis of the paper by Salawitch et al. can be performed.

Both the 1986 McMurdo and 1987 DC-8 data demonstrate that the column content of HCl, which is one of the major chlorine reservoirs at midlatitudes, is very low within the chemically perturbed region of the vortex, reaching column contents below 1×10^{15} molecules per cm^2 (Farmer et al., 1987). In addition, the column amount ratio of HCl to HF within the chemically perturbed region decreased significantly from a normal midlatitude value of 4 to a value less than

ANTARCTIC OZONE CHANGES

unity. Significant concentrations of chlorine nitrate were observed from McMurdo (Farmer et al., 1987). Figure 11.56 shows the vertical column abundances of the chlorine reservoir species, HCl and ClONO₂, and their sum, over the McMurdo station during September and October 1986. Table 11.4, from Farmer et al. (1987), tabulates the vertical column abundances of a number of chemical constituents observed at McMurdo station in 1986 using infrared absorption interferometry.

Table 11.4 Observed vertical column abundance (mol. cm⁻²)

Molecule	O ₃ * (× 10 ¹⁸)	O ₃ (× 10 ¹⁸)	NO (× 10 ¹⁵)	NO ₂ (× 10 ¹⁵)	HNO ₃ (× 10 ¹⁵)	ClONO ₂ (× 10 ¹⁵)	HCl (× 10 ¹⁵)
Date							
09/08	7.79	8.47 ± 0.20	2.4 ± 0.5	1.4 ± 0.5	19.6 ± 0.5	2.5 ± 0.5	1.56 ± 0.10
09/15	6.15	5.57 ± 0.20	2.6 ± 0.6	1.0 ± 0.4	14.9 ± 0.4	1.8 ± 0.3	1.48 ± 0.10
09/17	5.51	5.98 - 0.15	2.3 ± 0.4	0.5 ± 0.5	10.9 ± 0.2	1.5 ± 0.2	1.58 ± 0.10
09/20	5.83	5.92 - 0.15	2.1 ± 1.0		10.8 ± 0.2	2.0 ± 0.2	2.04 ± 0.15
09/24	8.04	8.06 - 0.20	3.6 ± 0.6	3.0 ± 2.5	16.6 ± 0.5	4.5 ± 0.4	2.69 ± 0.15
09/25	7.04	7.37 - 0.15	3.1 ± 0.2	1.9 ± 0.4	12.7 ± 0.4	3.7 ± 0.2	2.84 ± 0.10
09/28	6.26	6.44 - 0.10	3.0 ± 0.2	1.1 ± 0.4	11.2 ± 0.2	3.0 ± 0.2	2.85 ± 0.05
09/30	6.48	6.99 - 0.15	3.0 ± 0.5	2.2 ± 0.5	14.1 ± 0.2	3.8 ± 0.4	2.88 ± 0.10
10/01	6.26	6.33 - 0.12	3.5 ± 0.5	2.8 ± 0.5	15.1 ± 0.2	3.7 ± 0.2	2.99 ± 0.10
10/08	7.28	8.55 - 0.05	3.4 ± 0.3	3.0 ± 0.2	20.0 ± 0.2	3.5 ± 0.1	4.15 ± 0.05
10/12**	6.56	6.95 - 0.05	3.5 ± 0.4	2.1 ± 0.5	10.2 ± 0.1	3.4 ± 0.5	4.20 ± 0.05
10/15	5.78	5.85 - 0.05	2.9 ± 0.2	1.9 ± 0.3	11.5 ± 0.2	2.5 ± 0.1	4.17 ± 0.05
10/21	5.13	5.29 - 0.60	2.8 ± 0.8	2.4 ± 0.6	9.4 ± 0.4	2.4 ± 1.2	3.65 ± 0.25
10/24	5.67	5.55 - 0.40	3.7 ± 0.5	2.0 ± 1.5	10.7 ± 0.3	1.5 ± 0.8	5.29 ± 0.25

*Latitude-corrected TOMS O₃ column values; see text

**HF = 1.80 × 10¹⁵ ± 0.01

The bromine monoxide radical was observed at abundances of a few pptv within the chemically perturbed region of the vortex at the flight levels of the ER-2. The abundance of BrO decreased at lower altitudes. Total column measurements of BrO from the DC-8 and from McMurdo in 1987 are currently being analyzed. The low measured abundances of BrO mean that Scheme B is not the dominant catalytic mechanism for ozone destruction. Nevertheless, Scheme B probably accounts for 5 to 10 percent of the ozone destruction at the ER-2 flight levels.

11.4.2.4 Observations of Nitrogen Species

Observations of column amounts of NO, NO₂, HNO₃, and ClONO₂ at McMurdo in 1986 demonstrated that the atmosphere was denitrified (Mount et al., 1987; Farmer et al., 1987). Figures 11.57 and 11.58 show the temporal behavior of NO₂ from Mount et al. (1987), and of NO, NO₂, and HNO₃ from Farmer et al. (1987), respectively. The in situ ER-2 observations of the abundance of odd nitrogen, which is the sum of all nitrogen-containing reservoir and radical species, show, like total water, very low values within the chemically perturbed region of the vortex, indicating that the atmosphere has been denitrified as well as dehydrated. Abundances of NO_y of 8–12 ppbv were observed outside the chemically perturbed region, while abundances of 0.5 to 4 ppbv were observed inside the region. A similarly large change was observed for one of

ANTARCTIC OZONE CHANGES

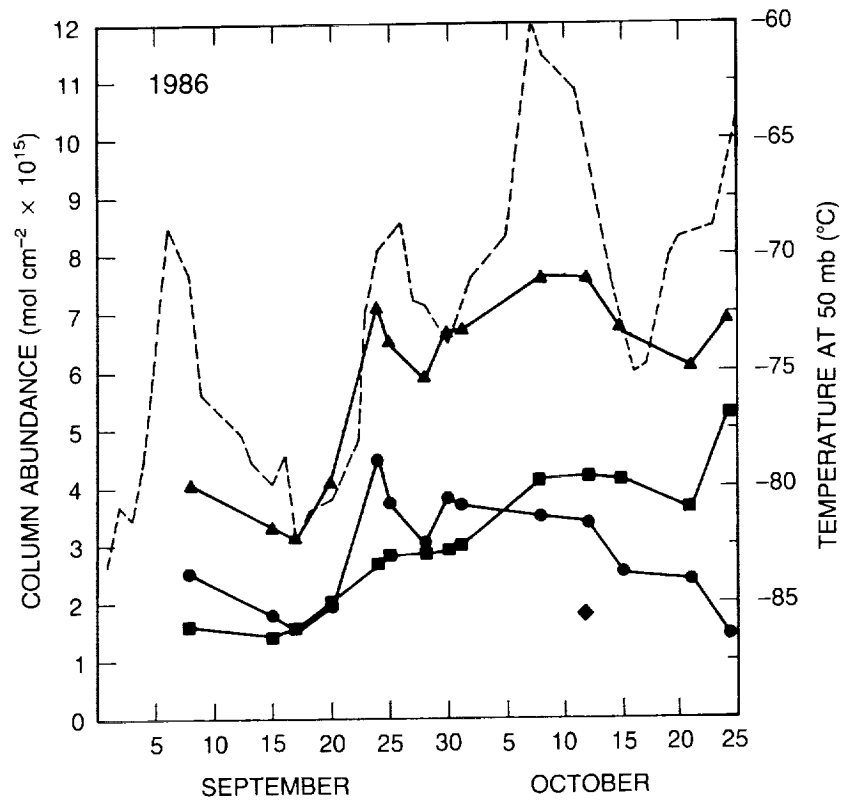

Figure 11.56. Vertical column abundances for the chlorine reservoir species HCl (squares), ClONO_2 (circles, and their sum (triangles). The column abundance value for the HF obtained on October 12, 1986, is also shown (diamond). The dotted line shows the temperature at the 50-mb level. (Farmer et al., 1987.)

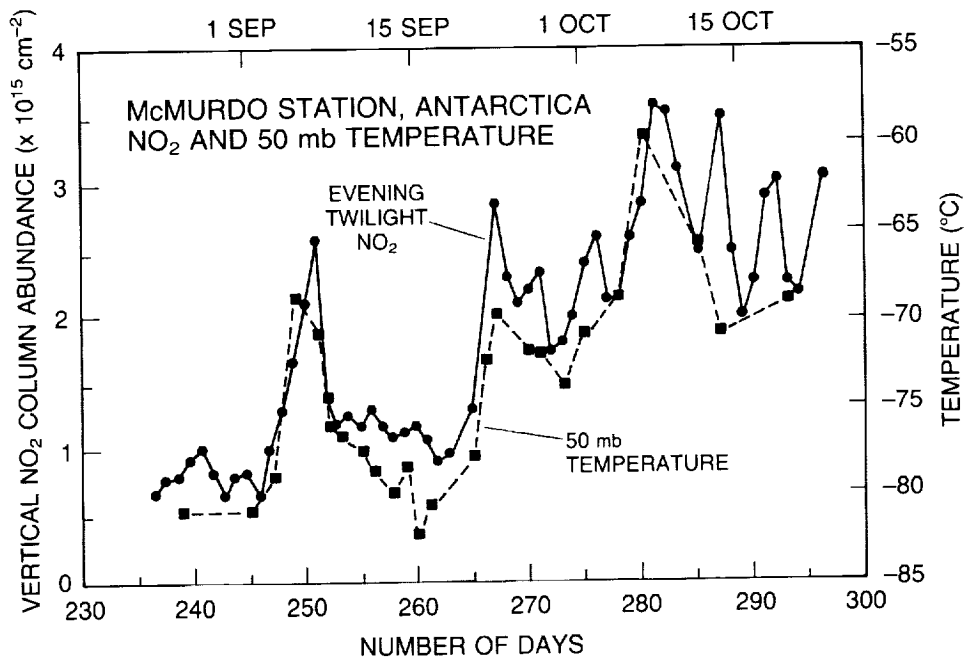

Figure 11.57. NO_2 vertical column over McMurdo from late August through mid-October, 1986, measured during evening twilight compared to 50 mb temperatures (from Mount et al., 1987.)

ANTARCTIC OZONE CHANGES

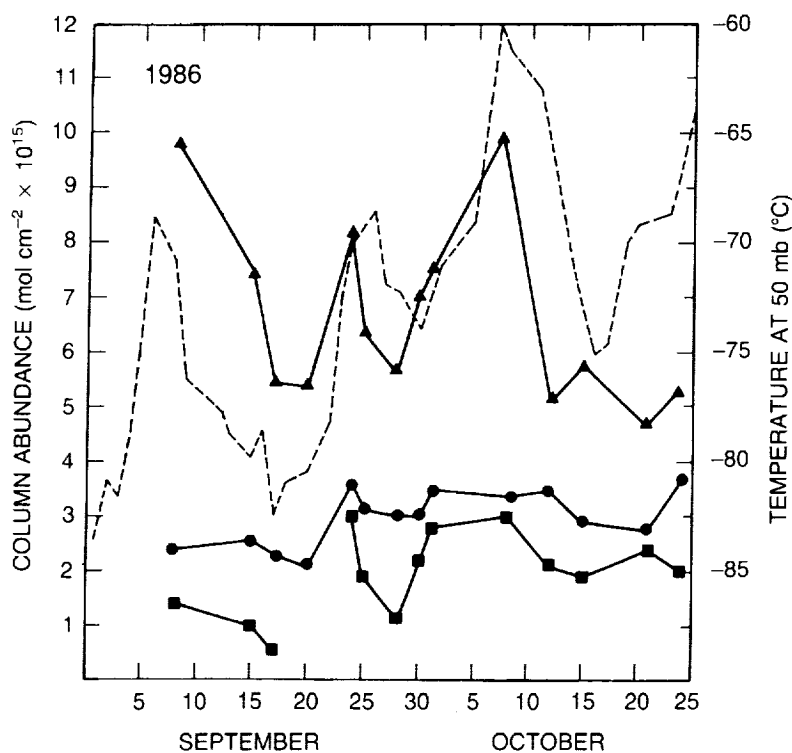

Figure 11.58. Vertical column abundances of HNO₃ (triangles), NO (circles), and NO₂ (squares), over McMurdo Station during September and October 1986. Note that the HNO₃ values are shown at half scale. The dotted line shows the temperature at the 50-mb level. (Farmer et al., 1987.)

the nitrogen components, NO. In addition, some of the NO_y observations suggest that NO_y component species are incorporated into PSC particles; nitrate was observed in the particle phase on some of the filter samples and on some of the wire impactor samples taken in the chemically perturbed region of the vortex. The column measurements of nitric oxide, nitrogen dioxide, and nitric acid made from the DC-8 exhibit a strong decrease in the abundance of these species toward the center of the vortex. These low values of nitrogen species are contrary to all theories requiring elevated levels of nitrogen oxides, such as the proposed solar cycle theory (Callis and Natarajan, 1986).

Observational data showing that air within the chemically perturbed region of the vortex is dehydrated and that the NO_y abundances are very low are consistent with theories that have been invoked whereby the chlorine reservoir species, ClONO₂ and HCl, can react on the surfaces of PSC's to enhance the abundance of active chlorine species, i.e., ClO. The observations also support the picture that the abundance of NO_y is low because odd nitrogen can be removed from the atmosphere by being tied up in ice crystals, which can then gravitationally settle to much lower altitudes. Low abundances of NO_y are needed to prevent the rapid reconversion of ClO to ClONO₂. This picture is further supported by the observations of low column abundances of HCl, by occasional observations of high levels of nitrate found in the ice particles, and by the visual and lidar observations of high cirrus and polar stratospheric clouds. The meteorology must play a role in the dehydration and denitrification processes. It is crucial to understand whether the necessary low temperatures are maintained radiatively or by ascent, or by some combination of both.

11.5 CAN WE EXPLAIN THE OBSERVED SPRINGTIME OZONE TREND OVER ANTARCTICA IN THE LAST 20 YEARS?

The mean total ozone column in October over the Antarctic station of Halley Bay (see Figure 11.1) exhibits a pronounced interannual variability and an overall weak trend in the 1970's, followed by a substantially faster decrease after 1979. This section will discuss possible explanations for the long-term spring decrease. It is not clear that this highly nonlinear behavior can be quantitatively explained within currently accepted concepts. A doubling of the Cl_x abundance, which probably occurred in the last 15 years or so, cannot, by itself, explain a 50 percent ozone reduction without invoking nonlinear mechanisms not yet included in current atmospheric models. A key question is: If the amount of odd chlorine becomes similar to or larger than the abundance of odd nitrogen, can the nonlinear chemical processes occurring under such conditions explain the rapid development of the springtime ozone hole after the mid-1970's? Wofsy et al. (1988) have a qualitative explanation of the phenomenon. However, there have been no attempts to date to quantitatively model Antarctic ozone over the last 20 years. Wofsy et al. proposed that if the initial concentration of HCl exceeds a critical value—0.5 times the concentration of NO_x before the onset of condensation—i.e.,

$$[\text{HCl}] > 0.5 [\text{NO}_x],$$

where $\text{NO}_x = \text{NO} + \text{NO}_2 + \text{NO}_3 + 2 \text{N}_2\text{O}_5$, high concentrations of reactive chlorine oxide radicals are rapidly produced, accompanied by efficient ozone destruction, by the following sequence of homogeneous and heterogeneous reactions:

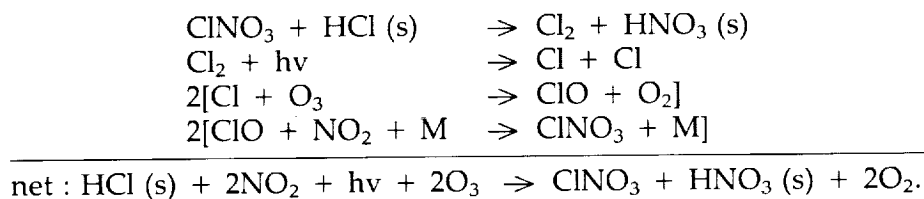

Production of unreactive ClNO_3 and HOCl is favored if HCl concentrations are lower than this value. Therefore, Wofsy et al. suggested that the onset of Antarctic ozone depletion in the mid- to late 1970's may, in part, reflect growth of HCl concentrations beyond this threshold.

Another cause for the abrupt reduction in Antarctic springtime ozone in the late 1970's and 1980's could be a cooling of the winter polar vortex. The consequence of even a slight climatological temperature change could be the production of increased polar stratospheric cloudiness, since heterogeneous nucleation of gases such as HNO_3 occurs only if the temperature becomes sufficiently low. Below a certain "threshold," NO_x and HNO_3 should start to disappear from the gas phase, and heterogeneous processes should become efficient and contribute to the conversion of inert forms of chlorine to active forms. However, it should be noted that there is no evidence for an unprecedented temperature change during late winter and early spring, i.e., August and September. Cold winters have been observed repeatedly in the past, although their frequency appears to have increased recently. In addition, the polar temperature appears to change with the QBO and, possibly, with solar activity (Labitzke and Van Loon, 1988). The amount of particles in the stratosphere has varied by several orders of magnitude on different occasions after the eruption of volcanoes, and there now appears to be some observational evidence of an increase in the PSC amount since the early 1980's (Iwasaka et al., 1986; McCormick, private communication).

ANTARCTIC OZONE CHANGES

11.6 WHAT ARE THE IMPLICATIONS FOR THE GLOBAL EARTH'S SYSTEM OF THE OZONE CHANGES OBSERVED OVER ANTARCTICA?

Besides its dramatic character and sudden appearance, a reason for concern about the ozone hole is that the processes that appear to play a decisive role in the polar environment, and that are not fully understood or included in atmospheric models, could be important at other latitudes and contribute to a global ozone depletion.

Since aerosols are present in the stratosphere at all latitudes, it is important to estimate if the processes involving heterogeneous reactions, and possibly leading to ozone destruction, could also occur in other regions of the atmosphere, for example, the Arctic. To address this problem, it is useful to note that the polar vortex of the Southern Hemisphere is, on average, nearly 10 K colder than the vortex of the Northern Hemisphere and that the composition and physical properties of the aerosols may be significantly different. However, it also should be noted that the average temperature is probably not the important quantity for dehydration. For example, in the Antarctic polar stratosphere, where the temperature reaches 180–190 K at 10–20 km altitude, the frost point of water vapor is reached and large ice particles can form; these may subside and disappear from the stratosphere, leaving the stratosphere dehydrated and denitrified. In the Arctic, where temperatures are in the 190–200 K range, relatively small $\text{HNO}_3 \cdot 3\text{H}_2\text{O}$ particles are expected to form in local regions. The Northern Hemisphere is very different in both the spatial extent of PSC's and meridional flow, and, hence, illumination of air masses exposed to the PSC's. The temperature increases at the end of the winter, essentially as a result of adiabatic processes, resulting in the disappearance of the PSC's before the Sun returns over the North Pole. However, because of the high planetary wave activity in the Northern Hemisphere during winter, the vortex is often significantly displaced from the pole and reaches an illuminated environment where photochemistry could initiate ozone destruction processes. Except for very special configurations where small regions of low temperature are formed, such events should not produce such dramatic ozone changes as observed in the Antarctic: the particles are probably not large enough to subside and remove active nitrogen from the northern polar vortex, and the time required for ClO to destroy ozone is probably longer than the time during which the vortex is illuminated. Finally, because of high dynamical activity and frequent breakdowns of the vortex, substantial transport of ozone from midlatitudes to the polar region occurs during a large portion of the winter; thus, any regions of low ozone formed should rapidly disappear. Measurements of key chemical constituents in the polar region of the Northern Hemisphere should nevertheless confirm these hypotheses and establish whether ozone is substantially changed in geographically limited cold and dynamically undisturbed areas.

The question of possible ozone depletion at midlatitudes as a result of heterogeneous chemistry must also be considered because a substantial number of particles is present at all latitudes inside the so-called Junge layer. These particles, which are small liquid drops, are composed of a mixture of sulfuric acid and water and are thus significantly different from the $\text{HNO}_3/\text{H}_2\text{O}$ particles in the PSC's (or haze). Therefore, the catalytic efficiencies of the particles in the Junge layer and in the PSC's differ, as discussed earlier in the section on heterogeneous processes (see Table 11.3). Furthermore, the mass density of the aerosols in the Junge layer is several orders of magnitude smaller than in the PSC's. Finally, the temperature of the lower stratosphere outside the polar regions is significantly higher (220 K) than in the polar vortex (190–210 K), except over the Tropics, where strong upward motions are present. Processes similar to those hypothesized to explain the formation of the ozone hole over Antarctica, for example, denitrification due to gravitational settling of large particles containing adsorbed nitric

acid, are thus unlikely to appear at midlatitudes, although some heterogeneous processes might periodically become important and lead to ozone destruction after large volcanic eruptions, when the amount of particles in the stratosphere is enhanced by several orders of magnitude. If heterogeneous processes are important at midlatitudes, then the concentrations of ClO should be elevated in the Junge layer; this can be evaluated by careful measurements. Calculations of the possible enhancement of ClO in the Junge layer have been performed by Rodriguez et al. (1988). Brune et al. (1988) reported measurements of the vertical distribution of the ClO radical at midlatitudes in the Northern Hemisphere from balloon (24–40 km) and aircraft platforms (15–20 km), as shown in Figure 11.59. It is clear that the abundance of ClO in the peak region of the aerosol layer, i.e., 16 to 20 km, is not significantly elevated as in the chemically perturbed region of the Antarctic ozone hole. This indicates that conversion of inactive reservoir forms of inorganic chlorine—i.e., HCl and ClNO₃—to the active form—i.e., ClO—does not appear to be enhanced detectably (less than a factor of 3 to 5) in this region of the stratosphere.

The possibility of a “dilution effect” of the polar anomaly observed in spring over Antarctica must be considered another possible global implication of the Antarctic ozone hole. Since the chemical lifetime of ozone in the lower stratosphere is of the order of a year, air masses with depleted ozone amounts move toward the Equator as soon as the winter vortex ceases to exist (November and December). As volumes of air with extremely low ozone are transported toward lower latitudes every year, the effects might partly accumulate, and a limited change in the total hemispheric ozone content could become noticeable. At present, this issue is being addressed using both multidimensional theoretical models and the TOMS satellite data by examining changes in total column ozone in both hemispheres.

11.7 QUESTIONS FOR THE FUTURE

The understanding of the mechanisms involved in the rapid decrease of ozone over Antarctica each spring since the late 1970's requires a continuing intense international research effort

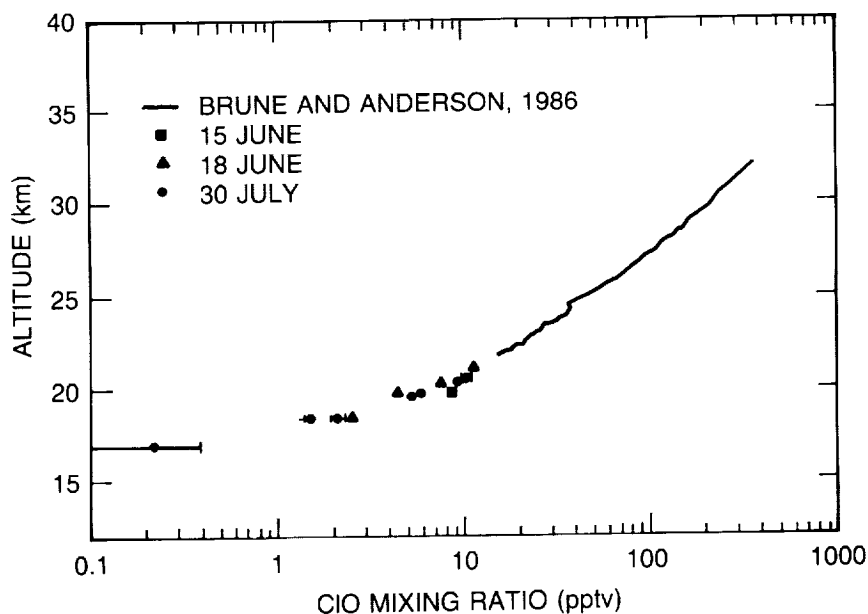

Figure 11.59. ClO mixing ratio versus altitude. Symbols are data from the three ER-2 flights; the line represents data from the May 1986 balloon flight. Error bars are 1σ statistical uncertainty. (Brune et al., 1988.)

ANTARCTIC OZONE CHANGES

involving additional field experiments (in the Antarctic and Arctic regions), laboratory work (dealing with homogeneous chlorine chemistry and heterogeneous processes), and modeling studies (involving coupled chemical, dynamical, and radiative models). The following questions should be urgently addressed:

- How is the Antarctic atmosphere preconditioned before ozone is depleted in late winter and early spring? Does the chemical composition change during the polar night?
- Do the observed abundances of ClO and BrO “quantitatively” explain the observed ozone decrease as a function of height and time?
- Can the ozone decrease be explained within a given year? Are the year-to-year changes understood?
- Is the dynamical morphology of the ozone hole understood? Are the relative roles of chemistry and dynamics explained?
- Can the region of depleted ozone become wider and deeper?
- Can mechanisms similar to those occurring in Antarctica destroy ozone at other latitudes (e.g., at the North Pole)? To what extent will the region of low ozone be diluted toward other latitudes in the Southern Hemisphere?
- Can a persistent ozone hole phenomenon change the climate and dynamics of the stratosphere?
- If the climate of the stratosphere is affected, do the changes tend to amplify the ozone hole?
- Can we design field measurements and laboratory experiments that would allow us to understand the composition and formation kinetics of polar stratospheric clouds?
- Can we develop laboratory experiments and theoretical models that allow us to measure and model PSC-induced heterogeneous reaction processes with the same level of accuracy we currently measure and model homogeneous gas phase reaction processes?

11.8 SUMMARY

11.8.1 Ozone Observations

Ground and satellite measurements (using several techniques) of total column ozone over high southern latitudes in springtime corroborate one another and provide a clear picture of the changes that have occurred. A significant change in the springtime total ozone content over the Antarctic was first reported by the British Antarctic Survey using the Dobson station data at Halley Bay (76°S, 27°W), with a smaller change seen at the Argentine Islands (65°S, 64°W) (Farman et al., 1985). The satellite data not only confirm the decrease reported from ground-station data, but demonstrate that the phenomenon is of large regional scale, at least the size of the Antarctic continent. The key aspects of the Antarctic ozone hole are that:

- Ground-based and satellite data clearly show that the abundance of ozone dropped rapidly after the late 1970's. However, given the high level of interannual variability in Antarctic

ozone, it is difficult to draw strong quantitative conclusions about the magnitude of ozone decreases during the 1970's.

- The development of the minimum occurs mainly during September.
- The rate of change of ozone within a given Antarctic spring appears to be increasing.
- The region of low ozone over Antarctica persisted until late November/early December 1987.
- Ozone was lower in 1987 at all latitudes south of 60°S than in any previous year since measurements began; the October monthly zonal mean total ozone amounts at 50°S, 60°S, 70°S, and 80°S were 8 percent, 20 percent, 41 percent, and 49 percent lower, respectively, than in 1979.
- In some instances, total column ozone changed dramatically (25–50 DU) over areas as large as several million square kilometers within a matter of a day or two; these reductions lasted for up to a few days.
- The altitude profiling by balloonborne ozonesondes has shown similar features at a number of stations consistent with the SAGE satellite results, providing confidence in the robustness of these results.
- Balloon ozonesonde and SAGE satellite data indicate that the ozone decrease over Antarctica is confined to a region between about 12 and 24 km.
- In October 1987, ozone concentrations between about 15 and 20 km decreased by more than 95 percent of their August values.

11.8.2 Polar Stratospheric Cloud Observations

The vertical extent of PSC's correlates with cold temperatures. Atmospheric temperatures increase during springtime starting at higher altitudes, resulting in a decrease with time of the maximum altitude at which PSC's can exist. The persistence of PSC's in Antarctica has increased since 1984. The 1985 observations show, for the first time, the occurrence of PSC's at 16 km throughout the end of September. Further, in 1987, PSC's lasted into October at altitudes as high as 18 km and 20 km, in sharp contrast to earlier years.

11.8.3 Temperature Observations

Substantial evidence has been presented for a decline since 1979 in the temperature of the lower stratosphere over Antarctica in October and November. The downward trends appear most strongly in October, when a substantial decline is observed in the middle as well as in the lower stratosphere. During November, the trend is confined to the lower stratosphere, with maximum negative trend of about 1 K per year centered at about the 100hPa level. August and September temperatures show little or no trend over the 1979–1985 period. The decline appears in both rawinsonde station data and NMC gridded data that include satellite information.

ANTARCTIC OZONE CHANGES

11.8.4 Transport Theories for the Antarctic Ozone Hole

The polar lower stratosphere of the Southern Hemisphere is very different from that of the Northern Hemisphere. Strong zonal symmetry of surface conditions in the Southern Hemisphere produces a circulation that is relatively symmetric and undisturbed by planetary wave activity; the lower stratosphere in which the lower stratospheric polar vortex is relatively intense, maintaining its integrity throughout winter and into spring. Dynamical modeling suggests that relatively little mixing occurs with air at other latitudes at altitudes where the vortex is sufficiently intense, and the air within the polar vortex thus remains very cold and dynamically isolated. In springtime, temperatures may be near or below radiative equilibrium; thus, solar heating might drive the seasonal change more in the Southern Hemisphere than in the Northern, where temperatures are kept well above radiative equilibrium by stronger wave forcing.

The observed Antarctic ozone decline occurs in the lower stratosphere, where transport by atmospheric motions has a major influence on the ozone-mixing ratio. A relatively small climate shift in the Southern Hemisphere could produce a significant change in the total ozone over Antarctica, since the transport of ozone into that region during winter and spring is limited by dynamical constraints associated with the symmetry of the circulation and is very weak in comparison to the almost complete mixing that occurs in the Northern Hemisphere. While colder temperatures at the beginning of spring, or later enhanced solar heating, could lead to transient upwelling that would contribute to the springtime ozone decline, it is unlikely that diabatic heating rates would be both sufficiently large and suitably distributed to produce the 1987 reduction.

Data suggest a decline in temperatures in the Antarctic lower stratosphere from 1979–1985 for October and November, and a corresponding decline in the wave driving for September. Calculations suggest that the radiative effect of the ozone decline is comparable in magnitude to the observed trend. The radiative temperature change is largest at the 100hPa level; its vertical structure in the lower stratosphere is very similar to that of the November trend. October shows a middle stratospheric temperature decline as well, which appears more likely to be associated with decreased wave driving during the previous month. Some combination of altered wave driving and radiative response to ozone changes seems necessary to explain the 1979–1985 trend.

Models attributing the decline only to changed transport processes require that low-ozone air be moved into the lower stratosphere from below. Such movement would also imply an increase of long-lived trace species of tropospheric origin. Aircraft data show that these trace species remain relatively constant during September as ozone declines significantly, so that transport is unlikely to be a significant contributor. These data support the hypothesis that a chemical sink for ozone is required within the polar vortex. However, the role of radiative and dynamical processes in establishing the conditions necessary for the ozone depletion and in controlling the temperature, cloudiness, and precise degree of isolation of the Antarctic ozone hole must be carefully considered.

11.8.5 Chemical Theories and Observations for the Antarctic Ozone Hole

Two distinctly different classes of chemical theories have been proposed to explain the observed loss of springtime Antarctic ozone. The first suggests that the abundance of the oxides of nitrogen is enhanced periodically by changes in solar activity; the second proposes that the efficiency of reactions involving chlorine and bromine species is enhanced. All current theories

that attempt to describe ozone loss in the Antarctic stratosphere in terms of catalytic chemical destruction involving chlorine or bromine have the following features:

- Conversion of a substantial fraction of the Cl_x contained in the reservoir molecules, HCl and ClONO_2 into active forms of chlorine, such as ClO , either by heterogeneous reactions in PSC's or by enhanced OH abundance.
- Cycles that effectively catalyze the recombination of O_3 with itself, involving ClO in the rate limiting step with HO_2 , itself, or BrO , forming HOCl , the Cl_2O_2 dimer, or Cl and Br , respectively.
- Drastic reduction in NO_2 abundance resulting from removal of NO_y as HNO_3 in the condensed phase of PSC's.

Recent laboratory data have shown conclusively that heterogeneous reactions of ClONO_2 (g) and N_2O_5 (g), with H_2O (s) and HCl (s), are rapid enough to play an important role in the chemistry of the Antarctic stratosphere. In particular, HCl was shown to diffuse readily into water ice crystals at low temperatures, forming solid solutions. Dissolved HCl in solid solutions was also shown to be very mobile, greatly enhancing its reactivity with reactant species on the crystal surfaces. The HNO_3 formed by ClONO_2 reactions with ice and HCl ice remains in the condensed phase, whereas the chlorinated products desorb into the gas phase.

Our understanding of the chemical composition of the springtime Antarctic atmosphere increased dramatically during 1986 and 1987. Observations of the vertical distribution and column content of a large number of species, including O_3 , H_2O , ClO , OCIO , ClONO_2 , HCl , BrO , HF , NO , NO_2 , HNO_3 , NO_y , N_2O , CH_4 , CCl_4 , CH_3CCl_3 , and CFC's 11 and 12, were made by ground-based observations from McMurdo in 1986 and 1987, and by in situ and remote-sensing techniques from aircraft in Punta Arenas in 1987. In addition, the size distribution, abundance, and composition of particles, the vertical distribution of aerosols from 12 to 28 km, and the size distribution were determined by aircraft, lidar, and balloonsondes, respectively, in an effort to understand the role of heterogeneous processes. The data clearly demonstrated that the chemical composition of the Antarctic stratosphere in springtime was highly perturbed. The distribution of chlorine species and the abundance and distribution of nitrogen species are significantly different from those observed at midlatitudes. It is not clear whether the abundance of total inorganic chlorine is perturbed relative to that expected, or just the partitioning. The amount of total water within some regions of the vortex is also significantly lower than anticipated.

Observational evidence strongly suggests that chemical mechanisms involving chlorine contribute to the formation of the Antarctic ozone hole, and meteorology sets up the special conditions required for the perturbed chemistry. The region of dehydrated and denitrified air maintained a sharply defined latitude gradient throughout the aircraft observation. On a purely meteorological definition, the vortex edge would be well outside the dehydrated, denitrified region. The meteorological flow must, therefore, have maintained a "containment vessel" in which the perturbed chemistry could proceed without being influenced by mixing in more normal stratospheric air from outside or below. Mixing at the region of sharp latitudinal gradient has the potential to supply nitrogen oxides that would tend to decelerate the chlorine chemistry. The meteorology is thus important in both the termination and initiation phases.

ANTARCTIC OZONE CHANGES

There is strong evidence that the chemical composition of the springtime Antarctic stratosphere is highly perturbed compared to midlatitudes. While the abundance of total chlorine is probably consistent with that expected, the partitioning of Cl_x was highly perturbed. The concentrations of HCl were low, the concentrations of OClO and ClO were significantly elevated, and concentration of ClONO₂ were somewhat elevated. The fraction of chlorine in an active form was significantly enhanced over that observed at midlatitudes; its abundance within the chemically perturbed region of the Antarctic atmosphere is greater by a factor of 100 to 500 than that measured at comparable altitudes at midlatitudes, reaching about 1 ppbv near 18 to 20 km. Within the chemically perturbed region of the vortex near 18.5 km, the abundance of ClO during September 1987 was sufficient to account for the destruction of ozone if our current understanding of the chlorine-ozone ClO dimer catalytic cycle is correct. The highest aircraft measurements showed the rate of ozone decrease during September to be consistent with simultaneously observed concentrations of ClO. Also consistent with ozone destruction by chlorine catalysis is that, during August, a consistent positive correlation between ClO and O₃ was observed, whereas by mid-September, as the ozone concentration was dropping at aircraft altitudes, a strong anticorrelation developed between ClO and O₃ that was usually present on both large and small scales within the chemically perturbed region.

The bromine monoxide radical was observed at abundances of a few pptv within the chemically perturbed region of the vortex at flight levels. The abundance of BrO decreased at lower altitudes. Total BrO column measurements taken from aircraft and balloonsonde in 1987 are being analyzed. The low measured abundances of BrO mean that the catalytic cycle involving the $\text{BrO} + \text{ClO} \Rightarrow \text{Br} + \text{Cl} + \text{O}_2$ reaction is not the dominant catalytic mechanism for ozone destruction. Nevertheless, Scheme B probably accounts for 5–10 percent of the ozone destruction at flight levels.

The in situ aircraft observations of the abundance of odd nitrogen show, like total water, very low values within the chemically perturbed region of the vortex, indicating that the atmosphere has been denitrified as well as dehydrated. Abundances of NO_y of 8–12 ppbv were observed outside the chemically perturbed region, while abundances of 0.5 to 4 ppbv were observed inside. In addition, some of the NO_y observations suggest that NO_y component species are incorporated into PSC particles; nitrate was observed in the particle phase on some of the filter samples and on some of the wire impactor samples taken in the chemically perturbed region of the vortex. The ground-based and aircraft column measurements of nitric oxide, nitrogen dioxide, and nitric acid exhibit a strong decrease in the abundance of these species toward the center of the vortex. These low values of nitrogen species are contrary to all theories requiring elevated levels of nitrogen oxides, such as the proposed solar cycle theory.

Observational data showing that air within the chemically perturbed region of the vortex is dehydrated and that the NO_y abundances are very low are consistent with theories that have been invoked whereby the chlorine reservoir species can react on the surfaces of PSC's to enhance the abundance of active chlorine species. The observations also support the picture that the abundance of NO_y is low because odd nitrogen can be removed from the atmosphere by being tied up in ice crystals, which can then gravitationally settle to much lower altitudes. Low abundances of NO_y are needed to prevent the rapid reconversion of ClO to ClONO₂.