

Atmospheric Chemistry Research Enterprise

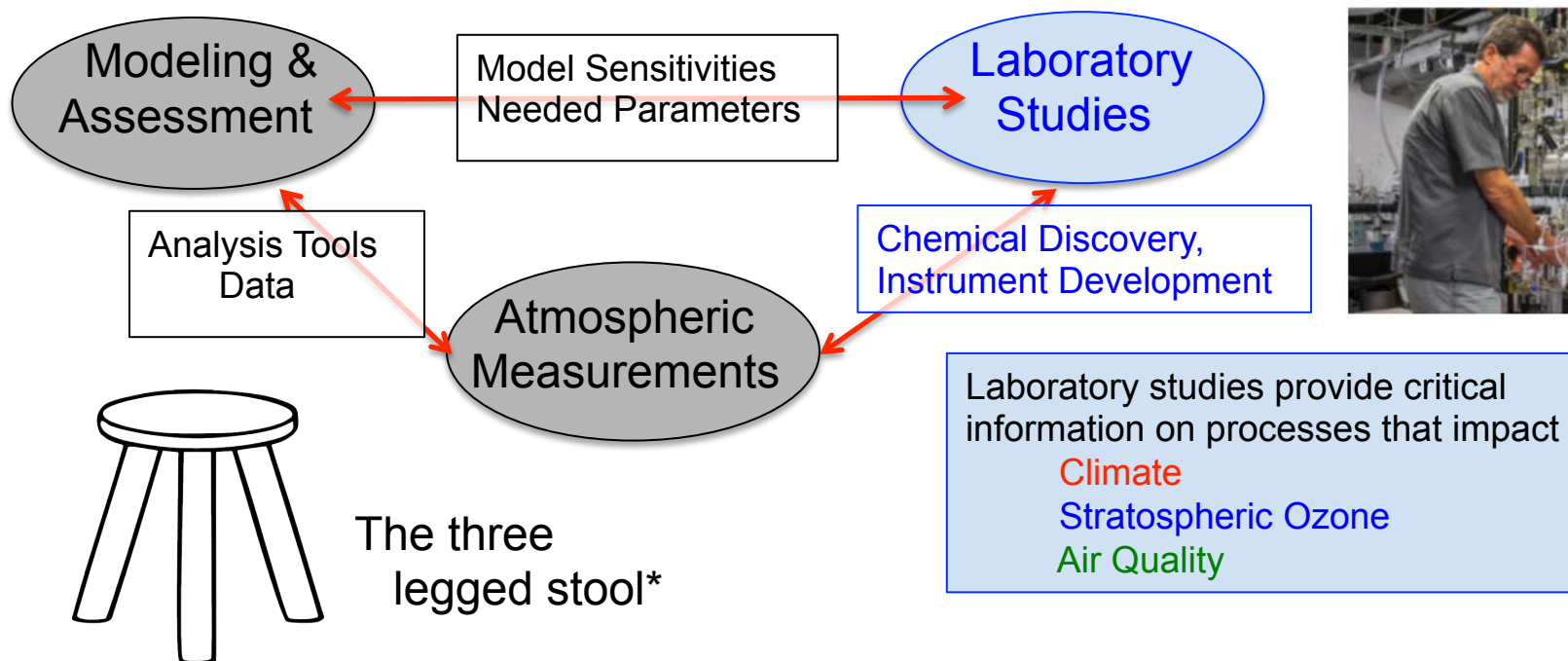

Abbatt, et al., *Atmos. Environ.*, 2014

- CSD has all three legs of the stool, resulting in significant synergies
- CSD continues to be a leader in Laboratory Studies, several staff are co-organizers of the IGAC Workshop on the Future of Atmospheric Laboratory Chemistry, June 17-19, 2015, Boulder, CO

Research Themes in Laboratory Studies

Atmospheric Radical Production

NOx-HOx Chemistry

What is the balance of radical production/loss?

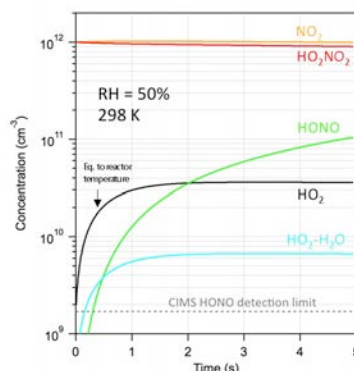
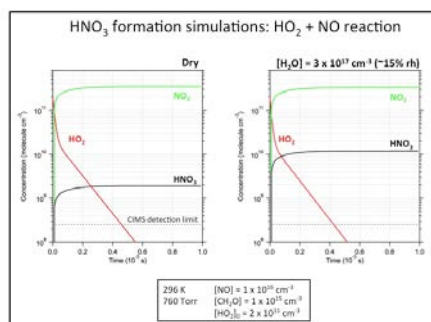

Aerosol Processes

New Particle Formation

SOA and Gas-Particle Chemistry

How is SOA formed, production/loss of BrC and SOA, are there health effects from particle chem?

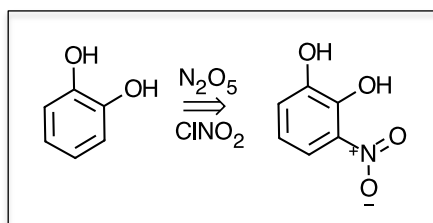

Ozone Depleting Substances and Replacements

Loss Processes and Products

How fast and where are compounds destroyed and are there products of concern?

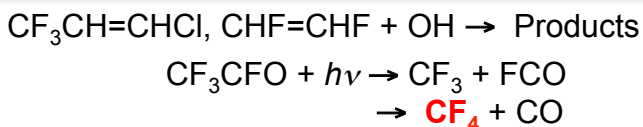

Biomass Burning

Emissions

Chemical Processes

Are there unique reactions and products that we need to know about?

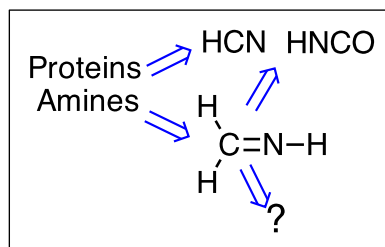

Payoffs/Stakeholders

Climate, Global, Air Quality model improvements.
Global atmospheric chemistry community

Better prediction of SOA formation, molecular-level details on compounds with health effects.
Regional atmospheric chemistry modelers and Health effects research community

Prediction of climate and ozone-depletion effects of replacement compounds.
Climate and Stratospheric Ozone assessments.

Better prediction of BB climate, AQ and Health impacts.
FIREX research effort, Wildland fire management professionals.

- CSD Laboratory Studies will provide policy-relevant science in these areas

Reduced Nitrogen Chemistry: Biomass Burning, Combustion, Agriculture



=> Amines
HNCO
???

Impacts: Brown Carbon, SOA formation, Health Effects

Example: Isocyanic Acid
Roberts et al., *PNAS*, 2011

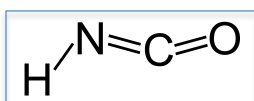

Gas Phase Chemistry: unreactive ($\tau > 6$ months)

Condensed Phase Chemistry

Solubility and Hydrolysis: Roberts et al., *PNAS*, 2011

Carbamylation: Brown Carbon, Health Effects



What are the Rate Constants and Products?

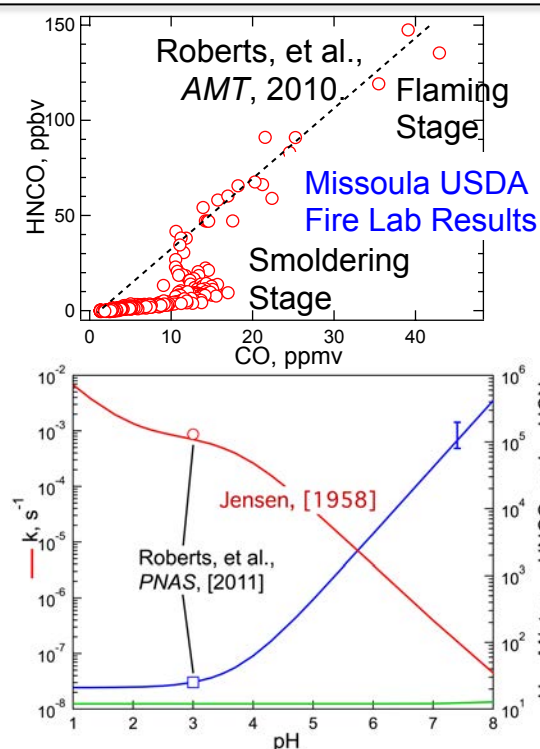

- Close linkage between Field and Laboratory work make CSD responsive to current atmospheric chemistry issues.
- CSD Laboratory studies will provide the chemical parameters needed to assess the Climate, Air Quality and Health effects of reduced nitrogen compounds.

Future Directions: Instrument development for laboratory and potential field deployment

Total Fixed Nitrogen Detector (Total Fixed Nitrogen = everything but N_2 and N_2O)

Provides Gas/Particle Speciation
Will be the basis for fundamental
calibrations of N_y compds

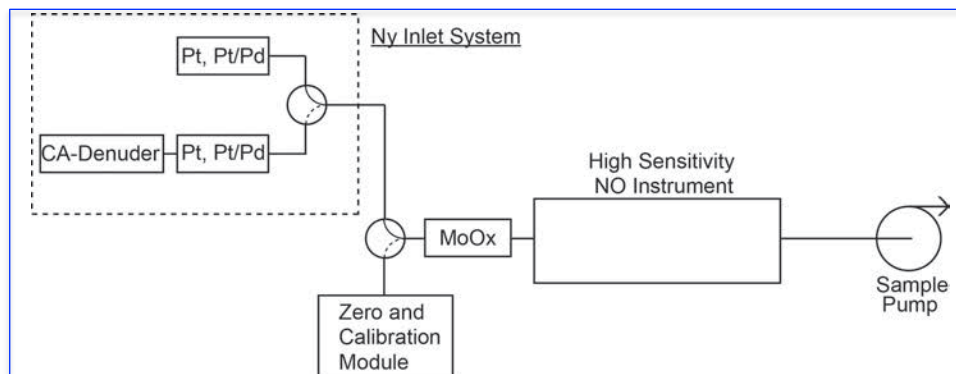

PiLS ESI-MS (Particle into Liquid Sampler, Electrospray Ionization Mass Spectrometry)

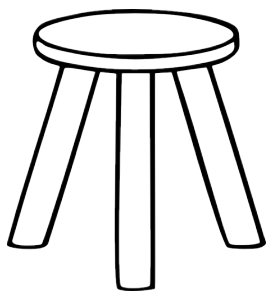
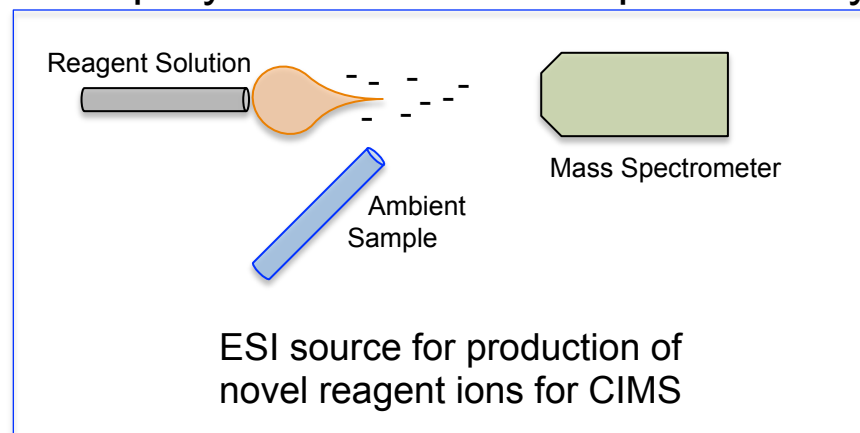
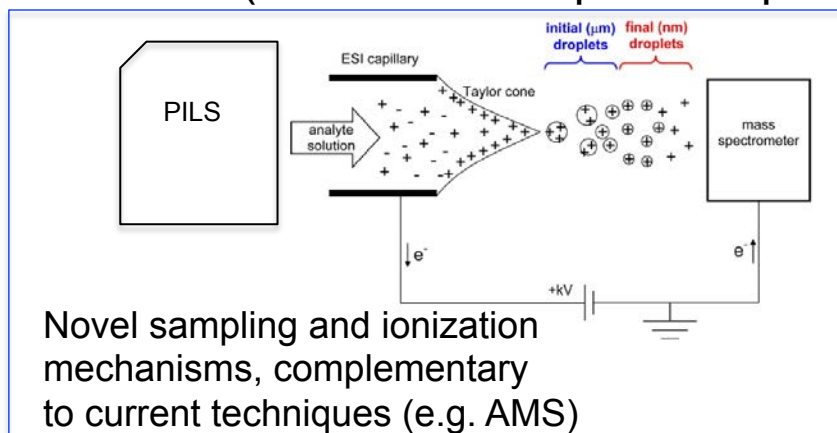

- CSD has the unique combination of Laboratory, Field and Modeling capabilities
- CSD Laboratory results will be used in Models, Assessments, and Stakeholder Decisions to enhance and optimize our management of atmospheric impacts of human activities